

CITY COUNCIL
CITY OF NORTHAMPTON
MASSACHUSETTS

Councilors:

- President Gina-Louise Sciarra, At-Large
- William H. Dwight, At-Large
- Michael J. Quinlan, Jr., Ward 1
- Karen Foster, Ward 2
- Vice-President James Nash, Ward 3
- John Thorpe, Ward 4
- Alex Jarrett, Ward 5
- Marianne L. LaBarge, Ward 6
- Rachel Maiore, Ward 7

Meeting Agenda
On-line Video Conference
Meeting Date: April 15, 2021
Meeting Time: 7 p.m.

The April 15, 2021 City Council meeting will be held via remote participation. The public can follow the council's deliberations by watching the meeting live on Comcast channel 15, live-streaming it on YouTube or joining the virtual meeting by phone or computer. For the active YouTube link, please see Northampton Open Media's website: <http://northamptonopenmedia.org/>

Live public comment will be available using telephone call-in or video conferencing technology beginning at 7 p.m.

INSTRUCTIONS FOR CALLING IN OR JOINING THE MEETING

Join Virtual Meeting: <https://bit.ly/2Oy1Nj4>

For telephone call-in, call:

+253 215-8785 US

+301 715-8592 US

MEETING ID: 926 8586 9036

PARTICIPANT #: #

PASSCODE: 618734

1. Announcement that Meeting is Being Held Via Remote Participation and Audio/Video Recorded

This meeting is being held via remote participation and audio/video recorded.

2. Public Comment

3. Roll Call

4. Public Hearings

A. **Announcement of Public Hearing on 21.197 National Grid/Verizon Petition for Installation of Underground Conduit Damon Road (Petition#23303524)**

Per M.G.L. Ch. 166, Section 22, the Northampton City Council will hold a public hearing on **Thursday, May 6, 2021 at 7:05 p.m.** on National Grid/Verizon New England's petition to install underground conduit on Damon Road (Petition #23303524). Instructions for accessing the hearing may be found on the May 6, 2021 City Council agenda to be posted on the city website (www.northamptonma.gov) at least 48 hours prior to the meeting. The City Council will hear all persons who wish to be heard thereon.

Documents:

[21.197 DPW Recommendation.pdf](#)

[21.197 Distribution Civil Drawings - REVISED.pdf](#)

[21.197 REVISED National Grid Petition for Installation of Underground Conduit on Damon Road.pdf](#)

B. **7:05 pm Public Hearing on 21.200 National Grid/Verizon New England Pole Petition for Warner Street (Petition#30293688)**

Per M.G.L. Ch. 166, Section 22, the Northampton City Council will hold a public hearing on **Thursday, April 15, 2021 at 7:05 p.m.** on National Grid/Verizon New England's petition to install one jointly-owned pole on Warner Street to serve two new homes (Petition# 30293688). The City Council will hear all persons who wish to be heard thereon.

Documents:

[21.200 DPW Recommendation.pdf](#)

[21.200 REVISED Cover Letter.pdf](#)

[21.200 Sketch.pdf](#)

[21.200 REVISED National Grid-Verizon Pole Petition for Warner Street.pdf](#)

5. Updates from Council President and Committee Chairs

6. Recognitions and One-Minute Announcements by Councilors

7. Communications and Proclamations from the Mayor

8. Resolutions

A. 21.231 A Resolution Declaring a Climate Emergency - 2nd reading

History:

- Passed 1st reading - 4/1/2021

Documents:

[21.231 A Resolution Declaring a Climate Emergency.pdf](#)

B. 21.233 A Resolution to Review and Revise the Rules and Committees of the City Council - 2nd reading

History:

- Passed 1st reading - 4/1/2021

Note: Council President to come up with structure and composition of Select Committee for second reading.

Documents:

[21.233 A Resolution to Review and Revise the Rules and Committees of the City Council.pdf](#)

9. Presentations

A. 2020 Special Committee for Review of Ordinances - Final Report

Presentation and Discussion with Ordinance Review Committee Members

Documents:

[FINAL Report of 2020 Special Committee for Review of Ordinances.pdf](#)

10. Consent Agenda

A. Minutes of March 4, 2021 and March 18, 2021

Documents:

[03-04-2021_City Council Minutes.pdf](#)

B. 21.206 Appointment of David Whitehill to the Planning Board, positive recommendation, City Services Committee - 4/5/2021

Planning Board

David Whitehill (Full Member), 60 Washington Avenue, Northampton

Term: March 2021-June 2022

To fill the term of resigned full member, Alan Verson

Documents:

[21.206 Appointment of David Whitehill to the Planning Board.pdf](#)

C. 21.210 Appointment to Planning Board - positive recommendation, City Services Committee - 4/5/2021

Planning Board

Samuel Taylor (Full Member), 245 North Street, Northampton

Term: July 2020-June 2023

Reappointment

Documents:

[21.210 Appointment to Planning Board.pdf](#)

D. 21.245 Petitions for Secondhand Dealer Licenses

Renewal Licenses for:

Antiques Corner, 81 Loudville Road
Applicant: Louis M. Farrick

Cumberland Rare Books, 9 1/2 Market Street
Applicant: Hosea Baskin

Electric Eye Records, 52 Main Street, #6
Applicant: Andrew Crespo

Norman E. Menard, 25 Garfield Avenue
Applicant: Norman E. Menard

Roz's Place, 6 Bridge Street
Applicant: Timothy Saldo

Sassy Pants Vintage & Used Clothing, 2 Conz St., Unit 2
Applicant: Kathleen Molongoski

The Family Jewels, 56 Green Street
Applicant: Richard J. Stone

Documents:

[21.245 Petitions for Second Hand Dealer Licenses.pdf](#)

E. 21.246 Petitions for Pool Table Licenses - Packards

Renewal Licenses for:

Packards, 14 Masonic Street

Weekday and Sunday Pool Table Licenses
Applicant: Robert E. McGovern

Documents:

[21.246 Petitions for Pool Table Licenses - Packards.pdf](#)

F. 21.247 Petitions for Junk Dealer Licenses

Renewal Licenses for:

Norman E. Menard, 25 Garfield Avenue
Applicant: Norman E. Menard

Richard & Sharon Huntley, 254 Easthampton Road
Applicant: Richard Huntley

Documents:

[21.247 Petitions for Junk Dealer Licenses.pdf](#)

11. Recess for Committee on Finance (See Separate Agenda)

12. Financial Orders (on 1st reading pending Finance review)

Rule 2.6 requires the Finance Committee to consider certain financial matters.

A. 21.244 An Order to Acquire and Amend Easements at the Mill River Greenway-Smith College - 1st reading

Documents:

[21.244 An Order to Acquire and Amend Easements at the Mill River Greenway-Smith College.pdf](#)

B. 21.248 An Order to Appropriate CPA Funds for Historic Northampton Collections Storage - 1st reading

Documents:

[21.248 An Order to Appropriate CPA Funds for Historic Northampton Collections Storage.pdf](#)

C. 21.249 An Order to Appropriate \$120,000 in CPA Funds Toward Habitat Housing on Burts Pit Road - 1st reading

Documents:

[21.249 An Order to Appropriate 120,000 in CPA Funds Toward Habitat Housing on Burts Pit Road.pdf](#)

D. 21.250 An Order to Appropriate \$14,500 in CPA Funds to Lilly

Library Stair Repair Project - 1st reading

Documents:

[21.250 An Order to Appropriate 14,500 in CPA Funds to Lilly Library Stair Repair Project.pdf](#)

E. 21.251 An Order to Appropriate \$70,000 in CPA Funds for Historic Preservation Plan - 1st reading

Documents:

[21.251 An Order to Appropriate 70,000 in CPA Funds for Historic Preservation Plan.pdf](#)

F. 21.252 An Order to Appropriate \$21,250 in CPA Funds for Damon House/Shepherd Barn Project - 1st reading

Documents:

[21.252 An Order to Appropriate 21,250 in CPA Funds for Damon House - Shepherd Barn Project.pdf](#)

G. 21.253 An Order to Appropriate \$60,000 in CPA Funds for Mill River Greenway Beach Project - 1st reading

Documents:

[21.253 An Order to Appropriate 60,000 in CPA Funds for Mill River Greenway Beach Project.pdf](#)

H. 21.254 An Order to Appropriate \$50,000 in CPA Funds to the Affordable Housing Fund - 1st reading

Documents:

[21.254 An Order to Appropriate 50,000 in CPA Funds to the Affordable Housing Fund.pdf](#)

I. 21.255 An Order Authorizing Acquisition of a Parcel of Land on the Southeasterly Side of Brierwood Drive - 1st reading

Documents:

[21.255 Order of Taking.pdf](#)
[21.255 Plans - Edbert Homes Inc.pdf](#)
[21.255 An Order Authorizing Acquisition of a Parcel of Land on the Southeasterly Side of Brierwood Drive.pdf](#)

J. 21.256 An Order Authorizing Waiver of Right of First Refusal for 2.93 Acres off Kennedy Road - 1st reading

Documents:

13. Financial Orders (on 2nd reading)

A. **21.230 An Order to Reprogram Funds to AOM Fire Suppression and Leeds Elementary Parking Lot Repaving - 2nd reading**

History:

- Positive recommendation, Finance Committee - 4/1/2021
- Passed 1st reading - 4/1/2021

Documents:

[21.230 An Order to Reprogram Funds to AOM Fire Suppression and Leeds Elementary Parking Lot Repaving.pdf](#)

B. **21.234 An Order to Accept DA Sullivan \$10,000 Gift to Fund Public Art Projects - 2nd reading**

History:

- Positive recommendation, Finance Committee - 4/1/2021
- Passed 1st reading - 4/1/2021

Documents:

[21.234 An Order to Accept DA Sullivan 10,000 Gift to Fund Public Art Projects.pdf](#)

C. **21.235 An Order to Appropriate Marijuana Community Impact Fee \$2.6 Million to Various Projects - 2nd reading**

History:

- Positive recommendation, Finance Committee - 4/1/2021
- Passed 1st reading - 4/1/2021

Documents:

[21.235 An Order to Appropriate Marijuana Community Impact Fee 2.6 Million to Various Projects.pdf](#)

D. **21.237 An Order to Appropriate Free Cash \$400,000 to Animal Control Facility - 2nd reading**

History:

- Positive recommendation, Finance Committee - 4/1/2021
- Passed 1st reading - 4/1/2021

Documents:

[21.237 An Order to Appropriate Free Cash 400,000 to Animal Control Facility.pdf](#)

14. Package of 11 Financial Orders to Implement FY2022 - FY2026 Capital

Improvement Program (CIP) - 2nd reading

History:

- Positive recommendation, Finance Committee - 4/1/2021
- Passed 1st reading - 4/1/2021

A. 21.219 FY22 CIP - An Order to Authorize Borrowing \$6 Million for Radio System Upgrade - 2nd reading

Documents:

[21.219 FY22 CIP - An Order to Authorize Borrowing 6 Million for Radio System Upgrade.pdf](#)

B. 21.220 FY22 CIP - An Order to Authorize Borrowing \$450,000 for Hotel Bridge - 2nd reading

Documents:

[21.220 FY22 CIP - An Order to Authorize Borrowing 450,000 for Hotel Bridge.pdf](#)

C. 21.221 FY22 CIP - An Order to Authorize Borrowing \$685,000 for DPW Vehicles - 2nd reading

Documents:

[21.221 FY22 CIP - An Order to Authorize Borrowing 685,000 for DPW Vehicles.pdf](#)

D. 21.222 FY22 CIP - An Order to Appropriate \$500,000 from Capital Stabilization to Arch Street Bridge Repairs - 2nd reading

Documents:

[21.222 FY22 CIP - An Order to Appropriate 500,000 from Capital Stabilization to Arch Street Bridge Repairs.pdf](#)

E. 21.223 FY22 CIP - An Order to Appropriate \$25,000 from Cemetery Perpetual Care for Cemetery Projects - 2nd reading

Documents:

[21.223 FY22 CIP - An Order to Appropriate 25,000 from Cemetery Perpetual Care for Cemetery Projects.pdf](#)

F. 21.224 FY22 CIP - An Order to Appropriate \$1.8 Million Free Cash to Various Projects - 2nd reading

Documents:

[21.224 FY22 CIP - An Order to Appropriate 1.8 Million Free Cash to Various Projects.pdf](#)

G. 21.225 FY22 CIP - An Order to Appropriate \$150,000 from PEG Access Fund to IT Services Projects - 2nd reading

Documents:

[21.225 FY22 CIP - An Order to Appropriate 150,000 from PEG Access Fund to IT Services Projects.pdf](#)

H. 21.226 FY22 CIP - An Order to Appropriate \$115,000 from Parking Receipts Reserved for Parking Projects - 2nd reading

Documents:

[21.226 FY22 CIP - An Order to Appropriate 115,000 from Parking Receipts Reserved for Parking Projects.pdf](#)

I. 21.227 FY22 CIP - An Order to Appropriate \$215,000 from Sale of Land RRA Account for NPS Projects - 2nd reading

Documents:

[21.227 FY22 CIP - An Order to Appropriate 215,000 from Sale of Land RRA Account for NPS Projects.pdf](#)

J. 21.228 FY22 CIP - An Order to Appropriate \$94,575 from Sale of Land RRA Account for Florence Fields Recreation Area - 2nd reading

Documents:

[21.228 FY22 CIP - An Order to Appropriate 94,575 from Sale of Land RRA Account for Florence Fields Recreation Area.pdf](#)

K. 21.229 FY22 CIP - An Order to Appropriate \$424,000 from Sale of Land RRA Account for Water Line Replacement - 2nd reading

Documents:

[21.229 FY22 CIP - An Order to Appropriate 424,000 from Sale of Land RRA Account for Water Line Replacement.pdf](#)

15. Orders

16. Ordinances (Not yet Referred)

Rule 5.2.3 provides that no ordinance shall be voted on by the City Council until it has been considered by the Committee on Legislative Matters.

A. 21.240 An Ordinance Relative to Parking on Front Street

Documents:

[21.240 An Ordinance Relative to Parking on Front Street.pdf](#)

B. 21.241 An Ordinance Relative to Parking on Grove Avenue

Documents:

[21.241 An Ordinance Relative to Parking on Grove Avenue.pdf](#)

C. 21.242 An Ordinance Relative to Parking on Florence Street

Documents:

[21.242 An Ordinance Relative to Parking on Florence Street.pdf](#)

D. 21.243 An Ordinance Relative to Parking on Main Street, Leeds

Documents:

[21.243 An Ordinance Relative to Parking on Main Street, Leeds.pdf](#)

17. Florence Traffic & Parking Ordinances Sponsored by Transportation & Parking Commission (TPC)

History:

- Scanlon Avenue and Cross Street Stop Signs (21.198 and 21.199) referred by City Council - 3/4/2021
- Pine/Maple/Mann Intersection & Pine Street Parking (21.213, 21.214, 21.215, 21.216) referred by City Council - 4/1/2021
- All positive recommendations, Legislative Matters - 4/12/2021

A. 21.198 An Ordinance Relative to a Stop Sign on Scanlon Avenue - 1st reading

Documents:

[21.198 An Ordinance Relative to a Stop Sign on Scanlon Avenue.pdf](#)

B. 21.199 An Ordinance Relative to Stop Signs on Cross Street - 1st reading

Documents:

[21.199 An Ordinance Relative to Stop Signs on Cross Street.pdf](#)

C. 21.213 An Ordinance Relative to Parking on Pine Street - 1st reading

Documents:

[21.213 An Ordinance Relative to Parking on Pine Street.pdf](#)

D. 21.214 An Ordinance Relative to Stop Signs on Maple Street, Mann Terrace and Pine Street - 1st reading

Documents:

[21.214 An Ordinance Relative to Stop Signs on Maple Street, Mann Terrace and Pine Street.pdf](#)

E. 21.215 An Ordinance Relative to Turning Restriction on Mann Terrace - 1st reading

Documents:

[21.215 An Ordinance Relative to Turning Restriction on Mann Terrace.pdf](#)

F. 21.216 An Ordinance Relative to One-Way Street on Mann Terrace - 1st reading

Documents:

[21.216 An Ordinance Relative to One-Way Street on Mann Terrace.pdf](#)

18. Ordinances

A. 20.181 An Ordinance Relative to Affordable Housing (350-6-12) - 2nd reading

History:

- Referred to Community Resources, Legislative Matters and the Planning Board
- 1/7/2021
- Positive recommendation, Community Resources - 2/23/2021
- Joint Planning Board/Legislative Matters Committee public hearing held - 3/8/2021
- Planning Board unanimously recommends adoption (David Whitehill absent) - 3/8/2021
- Positive recommendation, Legislative Matters - 3/8/2021
- Postponed to 4/1/2021 - 3/18/2021
- Amended to delete 'wood' from list of fossil fuels and add "or b) show evidence of Commonwealth funding that requires units be counted on the DHCD SHI"
- Passed 1st reading as amended

Documents:

[20.181 An Ordinance Relative to Affordable Housing - 350-6-12 - Post 1st reading.pdf](#)

B. 21.189 An Ordinance to Create an Incentive for Smaller Houses by Allowing Two Half-Scale Units to Count as a Single-Family for Density Purposes - 2nd reading

History:

- Referred to Community Resources, Legislative Matters and the Planning Board - 2/4/2021
- Positive recommendation, Community Resources - 2/23/2021
- Joint Planning Board/Legislative Matters Committee public hearing held - 3/8/2021
- Planning Board unanimously recommends adoption (David Whitehill absent) - 3/8/2021
- Positive recommendation, Legislative Matters - 3/8/2021
- Postponed to 4/1/2021 - 3/18/2021
- Passed 1st reading - 4/1/2021

Documents:

[21.189 An Ordinance to Create Incentive for Smaller Houses by Allowing Two Half-Scale Units to Count as a Single-Family for Density Purposes.pdf](#)

19. Information Requests (Charter Provision 2-7) and Committee Study Requests

20. New Business

21. Adjourn

Contact: G-L Sciarra, Council President
glsciarra@northamptonma.gov
(413) 570-3133



**CITY OF NORTHAMPTON, MASSACHUSETTS
DEPARTMENT OF PUBLIC WORKS
125 Locust Street
Northampton, MA 01060**

**413-587-1570
Fax 413-587-1576**

**Donna LaScaleia
Director**

Memorandum

To: Donna LaScaleia, Director of Public Works *Approved M 4-1-2021*
From: David Veleta, City Engineer
Date: March 31, 2021
Re: Council Order 21.197 – Petition for Installation and Maintenance of Underground Conduit and Manholes No. 23303524 – Damon Road Reconstruction Project MassDOT No. 608236 – Damon Road

I have reviewed Department of Public Works (DPW) records and submittals including images, sketches and reconstruction plans for MassDOT Damon Road project No. 608236. This petition with a revised plan dated March 24, 2021, includes the proposed construction of a line of underground electric conduits and manholes, including the necessary sustaining and protecting features, under and across the public ways or ways, by National Grid, referenced in City Council Order 21.197.

The installation is proposed to be located beginning at a point approximately 178 feet northeast of the centerline of the intersection of Industrial Drive and Damon Road and continuing in a northeast direction. National Grid proposes to install Manhole 1 with approximately 20 feet of four 5-inch, future use conduit to the northwest, approximately 45 feet of two 5-inch conduit to pole P7-25, approximately 377 feet of six 5-inch conduit from Manhole 1 to Manhole 2, approximately 37 feet of two 5 inch conduit from Manhole 2 to P7-50, and approximately 20 feet of four 5-inch, future use conduit to the northeast from Manhole 2, as shown on the attached plan dated March 24, 2021.

No potential conflicts were observed, but the contractor shall use caution when excavating since the exact location of the existing sewer force main is unknown.

A trench permit approved by the DPW has already been issued for the Damon Road project to Gagliarducci Construction who will be installing the manholes and conduit under contract with MassDOT. This permit will be revised to reflect the specifics of the above work upon approval of this petition by Council.

Pole & UG Petition/Permit Request Form

City

Town of _____ **WR #** _____
(circle one)

Install _____ **SO**
(quantity) **JO** Poles on _____
(circle one) (street name)

Remove _____ **SO**
(quantity) **JO** Poles on _____
(circle one) (street name)

Relocate _____ **SO**
(quantity) **JO** Poles on _____
(circle one) (street name)

Beginning at a point approximately _____ **feet** _____ **of the centerline**
(distance) (compass heading)

of the intersection of _____
(street name)

and continuing approximately _____ **feet in a** _____ **direction.**
(distance) (compass heading)

Install underground facilities:

Street(s) _____

Description of Work:

ENGINEER _____

DATE _____

GENERAL NOTES:

- CONTRACTOR TO PROVIDE AS-BUILT INFORMATION 10 DAYS AFTER COMPLETION OF CONDUIT INSTALLATION WORK.
- THE LOCATIONS OF UNDERGROUND STRUCTURES SHOWN HEREIN ARE DEPICTED ACCORDING TO THE BEST AVAILABLE INFORMATION. THEY ARE NOT GUARANTEED TO BE CORRECT OR COMPLETE. IT IS THE RESPONSIBILITY OF THE CONTRACTOR TO CONFIRM ALL CONDITIONS IN THE FIELD AND MAKE ADJUSTMENTS AS REQUIRED TO ACCOMMODATE THE WORK BY GETTING APPROVAL FROM NATIONAL GRID CONSTRUCTION MANAGEMENT FIRST. IT IS ASSUMED ALL PREMISES HAVE WATER, GAS, TEL. ELEC. SEWER, ETC. LATERAL CROSSINGS WHICH SHOULD BE INCLUDED IN THE BASE BID.
- ANY QUESTIONS REGARDING THE CIVIL ENGINEERING DESIGN OF THESE CONSTRUCTION PLANS SHOULD BE REFERRED TO TRC DISTRIBUTION ENGINEER DANIEL LOPEZ AT 774-235-2603 OR DAVID TERK AT 508-298-1523.
- DO NOT DEVIATE FROM THESE PLANS WITHOUT FIRST CONTACTING NATIONAL GRID CIVIL CONSTRUCTION SUPERVISOR:
 - GARY BELLOWS 413-652-9222
- ALL UNDERGROUND CONSTRUCTION SHALL BE INSPECTED AND APPROVED BY NATIONAL GRID PERSONAL PRIOR TO CONCRETE ENCASMENT AND BACKFILL. CONTRACTOR SHALL MANDREL, PROVE, AND INSTALL MULE TAPE IN ALL CONDUITS PER NATIONAL GRID CONSTRUCTION STANDARDS UNDER SUPERVISION OF NATIONAL GRID CONSTRUCTION SUPERVISOR.
- CONTRACTOR TO ARRANGE TO HAVE ALL FOREIGN UTILITIES VERIFY THEIR LOCATIONS IN THE FIELD PRIOR TO START OF EXCAVATION WORK BY CONTACTING DIG SAFE AT "811", 1-888-DIG-SAFE. NOT ALL UTILITY SERVICES TO PROPERTIES ARE SHOWN ON THESE PLANS. REFER TO NOTE 2 ABOVE.
- PROTECT ALL MUNICIPAL, STATE, AND FEDERAL SURVEY CONTROL MONUMENTS AND BENCH MARKS. CONTRACTOR TO CONTACT RESPECTIVE MUNICIPAL ENGINEERING DEPARTMENTS FOR TYPES AND LOCATIONS BEFORE STARTING WORK AS REQUIRED.
- PROTECT ALL PLANTS AND TREES AND THEIR ROOT SYSTEMS FROM MECHANICAL AND ENVIRONMENTAL DAMAGE DURING EXCAVATION. BACKFILL ROOT AREAS WITH SOIL HAVING TEXTURE AND FERTILITY TO SUSTAIN PLANT LIFE. CONTRACTOR TO REMOVE ALL ROOTS OF DEAD TREE STUMPS FROM TRENCH PRIOR TO PLACING CONDUIT. CONTRACTOR IS RESPONSIBLE FOR THE INSTALLATION AND MAINTENANCE OF NECESSARY EROSION CONTROL (SILT SACKS, HAY BALES, CHECK DAMS, ETC.) APPROVED BY THE STATE, CITY/TOWN, AND QUONSET DEVELOPMENT CORPORATION AS REQUIRED FOR THE DURATION OF THE PROJECT.
- THE FOLLOWING MINIMUM CLEARANCES SHALL BE MAINTAINED UNLESS OTHERWISE NOTED:

UTILITY	CROSSING	PARALLEL
GAS MAIN	12"	12"
GAS SERVICE	12"	12"
WATER MAIN	12"	12"
WATER SERVICE	12"	12"
TELEPHONE/COMMUNICATION FACILITIES	12"	12"
STORM & SANITARY SEWERS	12"	12"
RAIL ROAD CROSSINGS	50"	50"

PLEASE NOTE, ANY DEVIATIONS FROM THESE MINIMUM CLEARANCES MUST BE REVIEWED AND APPROVED BY NATIONAL GRID & TRC.

UTILITY SERVICES AND LATERALS TO BUILDINGS ARE NOT SHOWN ON THESE PLANS. CONTRACTOR TO VERIFY THEIR LOCATIONS IN THE FIELD AND SUPPORT, PROTECT, MAINTAIN, AND WORK AROUND THEM AS REQUIRED IN ORDER TO COMPLETE THE PROPOSED WORK.
- ALL CONTRACTORS SHALL COMPLY WITH MINIMUM WORKING CLEARANCES FROM ALL ENERGIZED OVERHEAD EQUIPMENT AND CONDUCTORS PER OSHA REGULATIONS 1910.3333. IF MINIMUM WORKING CLEARANCES CAN NOT BE MET, CONTRACTOR MUST CONTACT NATIONAL GRID TO EVALUATE ALTERNATIVE MEASURES. THESE MEASURES MAY INCUR ADDITIONAL COSTS.
- CONDUIT TO BE PLACED AT MINIMUM 30" BELOW ELEVATION OF NEAREST PORTION OF ROAD PAVEMENT UNLESS OTHERWISE NOTED. MANHOLE ROOF TO HAVE A MINIMUM 18" OF COVER FROM FINISH GRADE UNLESS OTHERWISE NOTED.
- ALL WORK SHALL COMPLY WITH ALL APPLICABLE FEDERAL, STATE, AND MUNICIPAL CODES, AS WELL AS THE REQUIREMENTS OF THE NATIONAL ELECTRIC SAFETY CODE, OSHA REGULATIONS AND NATIONAL GRID CONSTRUCTION STANDARDS/REQUIREMENTS.
- AREAS WHERE EXCAVATION IS IN ROCK LEDGE, PROVIDE A SIX (6) INCH MINIMUM SELECT FILL CUSHION AROUND CONDUITS AND TWELVE (12) INCH CUSHION AROUND MANHOLE.

- CONTRACTOR SHALL COMPLY WITH ALL APPLICABLE FEDERAL, STATE AND LOCAL REGULATIONS REGARDING REMOVAL AND/OR DISPOSAL OF ANY AND ALL EQUIPMENT AND MATERIALS.
- CONTRACTOR SHALL MAINTAIN A FULL SIZE SET OF SCALED DRAWINGS (100% OF ALL PRINTS) ON SITE AT ALL TIMES DURING THE WORK.
- CONTRACTOR TO RECORD AND DOCUMENT A SINGLE, MULTI-PAGE .PDF PHOTOLOG OF THE ENTIRE WORK AREA. CONTRACTOR TO PROVIDE NATIONAL GRID PROJECT MANAGER A COPY OF THE PRE-CONSTRUCTION PHOTOLOG ALONG WITH A POST-CONSTRUCTION PHOTOLOG OF THE ENTIRE WORK AREA UPON COMPLETION OF ALL CIVIL WORK IN THE FIELD.
- REFER TO ALL NATIONAL GRID CIVIL CONSTRUCTION SPECIFICATIONS INCLUDED IN THE BID DOCUMENTS FOR ADDITIONAL INFORMATION REGARDING MANHOLE AND DUCT BANK INSTALLATION.

PLEASE NOTE:
THE 12" MINIMUM CLEARANCES FROM OTHER UTILITIES SHALL BE MAINTAINED WHEREVER POSSIBLE. IF THE 12" MINIMUM CLEARANCE CANNOT BE ACHIEVED IN THE FIELD, CONTRACTOR TO USE ACCEPTABLE ALTERNATIVE MEANS TO PROTECT THE OTHER UTILITIES AND/OR CONFIRM APPROVAL FROM THE UTILITY OWNER FOR LESS THAN MINIMUM CLEARANCE.

DISTRIBUTION DRAWING INDEX

REFER TO DRAWINGS:

CIVIL & PROFILE DRAWINGS	PROPOSED MANHOLE DRAWINGS	DETAIL DRAWINGS
PP-1	DET-1	DET-1 DET-2

ABBREVIATIONS

NOTE: NOT ALL ABBREVIATIONS LISTED BELOW ARE USED FOR THIS PROJECT

#	NUMBER	HV	HIGH VOLTAGE
&	AND	INV	INVERT
⊙	AT	KV	KILOVOLT
>	GREATER THAN	KVA	KILOVOLT-AMPERE
<	LESS THAN	L	LENGTH
∅	DIAMETER	LF	LINEAR FOOT
A	AMPERE	LV	LOW VOLTAGE
ABAN	ABANDONED	M	METER
ABAND	ABANDONED	MAX	MAXIMUM
AC	AIR CONDITIONER	MH	MANHOLE
AC	ALTERNATING CURRENT	MIN	MINIMUM
APPROX. APP	APPROXIMATE	MISC	MISCELLANEOUS
B/	BOTTOM OF	MJ	MECHANICAL JOINT
BIT	BITUMINOUS	MW	MONITORING WELL
BLDG	BUILDING	N	NORTH
BVCE	BEGIN VERTICAL CURVE ELEVATION	N/F	NOW OR FORMERLY
BVCS	BEGIN VERTICAL CURVE STATION	NGVD	NATIONAL GEODETIC VERTICAL DATUM
C/C	CENTER TO CENTER	NIOSH	NATIONAL INSTITUTE OF OCCUPATIONAL SAFETY AND HEALTH
CB	CATCH BASIN	PC	POINT OF CURVATURE
CI	CAST IRON	PCB	POLYCHLORINATED BIPHENYL
CL	CENTERLINE	PE	POLYETHYLENE
CLR	CLEAR	PILC	PAPER IN LEAD COVERED CABLE
CMP	CORRUGATED METAL PIPE	PIV	POST INDICATOR VALVE
CMPA	CORRUGATED METAL PIPE ARCH	PROP	PROPOSED
CMP1	COMPACT CABLE	PT	POINT, POINT OF TANGENCY
COM	COMMUNICATIONS	PVC	POLYVINYL CHLORIDE
CONC	CONCRETE	PVI	POINT OF VERTICAL INTERSECTION
CP	CONTROL POINT	R	RADIUS
CS	CARBON STEEL	RCP	REINFORCED CONCRETE PIPE
CU	COPPER	REQ'D	REQUIRED
CW	CLEAN WATER	RET	RETAINING
D	DIAMETER	RR	RAIL ROAD
DC	DIRECT CURRENT	S	SLOPE
DI	DUCTILE IRON	SCADA	SUPERVISORY CONTROL AND DATA ACQUISITION
DIA	DIAMETER	SCH	SCHEDULE
DMH	DRAIN MANHOLE	SD	STORM DRAIN
DWG	DRAWING	SF	SQUARE FEET
E	EAST	SMH	SANITARY MANHOLE
EL	ELEVATION	SQ	SQUARE
ELEC	ELECTRIC	SS	STAINLESS STEEL
ELEV	ELEVATION	STA	STATION
EMH	ELECTRIC MANHOLE	STL	STEEL
EOP	EDGE OF PAVEMENT	STORM	STORMWATER
EUE	EXISTING UNDERGROUND ELECTRIC	T&B	TOP AND BOTTOM
EUT	EXISTING UNDERGROUND TELEPHONE	T/	TOP OF
EVCE	END VERTICAL CURVE ELEVATION	TEL	TELEPHONE
EVCS	END VERTICAL CURVE STATION	TV	TELEVISION
EW	EACH WAY	TYP	TYPICAL
EX, EXIST	EXISTING	UE	UNDERGROUND ELECTRIC
FFE	FINISH FLOOR ELEVATION	UG	UNDERGROUND
FM	FORCE MAIN	UNO	UNLESS NOTED OTHERWISE
FO	FIBER OPTIC	V	VOLT
GALV	GALVANIZED	var	VOLT-AMPERE REACTIVE
GEN	GENERATOR	VC	VERTICAL CURVE
GRAN	GRANITE	VCP	VITREOUS CLAY PIPE
HDD	HORIZONTAL DIRECTIONAL DRILLING	VERT	VERTICAL
HDPE	HIGH DENSITY POLYETHYLENE	VP	VALVE PIT
HH	HANDHOLE	W	WATER
HORIZ	HORIZONTAL	W/	WITH

LEGEND

	CATCH BASIN CURB INLET
	CATCH BASIN
	DRAIN LINE/MANHOLE
	SEWER LINE/MANHOLE
	COMBINED SEWER/RAIN-MANHOLE
	ELECTRIC LINE/MANHOLE
	ELECTRIC LINE
	LIGHT POLE
	GAS LINE/GATE
	RETIRED GAS LINE
	HYDRANT
	WATER LINE (LOW PRESSURE)/GATE
	WATER LINE (HIGH PRESSURE)/GATE
	ABANDONED WATER LINE
	TELEPHONE LINE/MANHOLE
	TELEPHONE LINE
	CONCRETE CURB
	BITUMINOUS CONCRETE CURB
	VERTICAL GRANITE CURB
	CHAIN LINK FENCE
	WOOD STOCKADE FENCE
	HANDRAIL
	METAL RAILING FENCE
	EDGE OF GRAVEL
	APPROXIMATE STREET LINE
	WORCESTER HIGHWAY BOUND
	STONE BOUND/DRILL HOLE
	DRILL HOLE
	IRON PIPE/PIN
	FOUND
	BUILDING
	PARCEL ADDRESS
	MONUMENT/TRVERSE POINT W/ APPROXIMATE STATE PLANE COORDINATE
	BIT. CONC.
	BY RECORD
	BOLLARD
	BRICK RETAINING WALL
	CONCRETE BLOCK RETAINING WALL
	CONCRETE RETAINING WALL
	CONCRETE STAIRS
	COBBLESTONE EDGING
	PROPOSED PADMOUNT TRANSFORMER
	EXISTING 2-WAY MANHOLE
	PROPOSED 2-WAY MANHOLE
	EXISTING SWITCHGEAR MANHOLE
	PROPOSED SWITCHGEAR MANHOLE

124 Grove St. Franklin, MA 02038		PROJECT No:270728		DL DESIGNED AS DRAWN CHECKED APPROVED			
REV DESCRIPTION DATE DES CHK APP				MASSDOT DAMON RD LAYOUT PLAN		DATE: 3/24/21 NTS: [] SCALE: []	
				REVIEW 1 [] REVIEW 2 []		TRC WR#23303524 G-1 REV: 0	

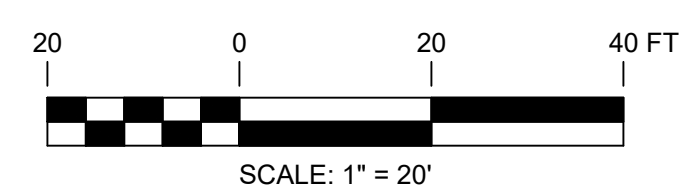
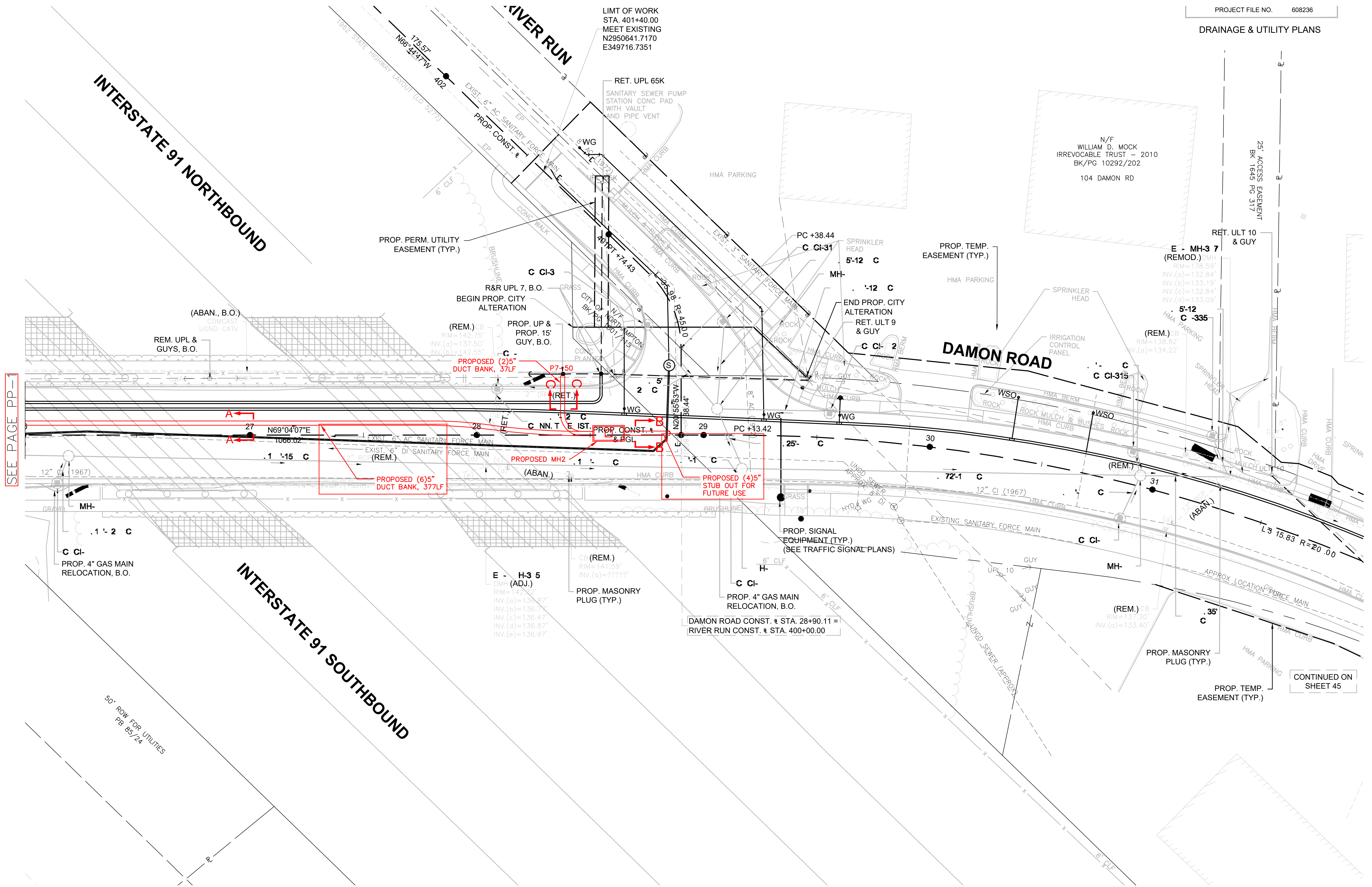
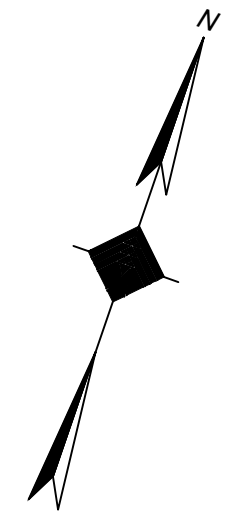

124 Grove St. Franklin, MA 02038		PROJECT NO. 270728																									
MASSDOT DAMON RD LAYOUT PLAN				PP-2 WR#23303524																							
<table border="1" style="width: 100%; border-collapse: collapse;"> <thead> <tr> <th style="font-size: x-small;">REV</th> <th style="font-size: x-small;">DESCRIPTION</th> <th style="font-size: x-small;">DATE</th> <th style="font-size: x-small;">DES</th> <th style="font-size: x-small;">CHK</th> <th style="font-size: x-small;">APP</th> </tr> </thead> <tbody> <tr> <td style="height: 20px;"> </td> <td> </td> <td> </td> <td> </td> <td> </td> <td> </td> </tr> </tbody> </table>	REV	DESCRIPTION	DATE	DES	CHK	APP							<table border="1" style="width: 100%; border-collapse: collapse;"> <tr> <td style="font-size: x-small;">DESIGNED</td> <td style="font-size: x-small;">AS</td> <td style="font-size: x-small;">DRAWN</td> <td style="font-size: x-small;">CHECKED</td> <td style="font-size: x-small;">APPROVED</td> </tr> <tr> <td style="font-size: x-small;">REVIEW 1</td> <td style="font-size: x-small;">REVIEW 2</td> <td style="font-size: x-small;">DATE</td> <td style="font-size: x-small;">SCALE</td> <td style="font-size: x-small;">REV.</td> </tr> </table>	DESIGNED	AS	DRAWN	CHECKED	APPROVED	REVIEW 1	REVIEW 2	DATE	SCALE	REV.	3/24/21 DATE AS NOTED SCALE		PP-2 WR#23303524	REV. 0
REV	DESCRIPTION	DATE	DES	CHK	APP																						
DESIGNED	AS	DRAWN	CHECKED	APPROVED																							
REVIEW 1	REVIEW 2	DATE	SCALE	REV.																							

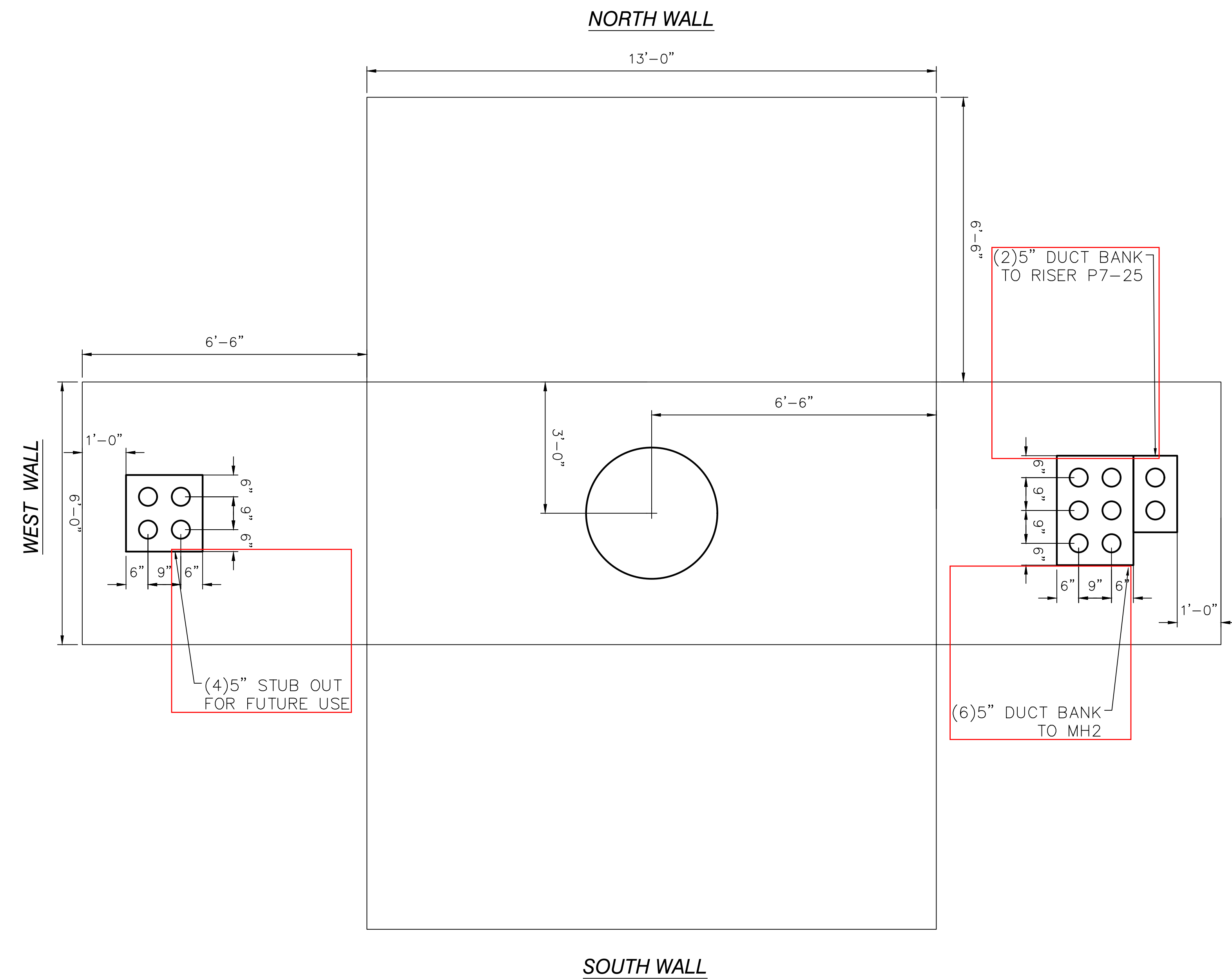

MANHOLE NUMBER: MH1

SIZE: L=13' W=6' H=6'-6"
 MANHOLE RING SIZE: 36"
 MANHOLE COVER SIZE: 26"
 CHIMNEY HEIGHT: 2'-0"

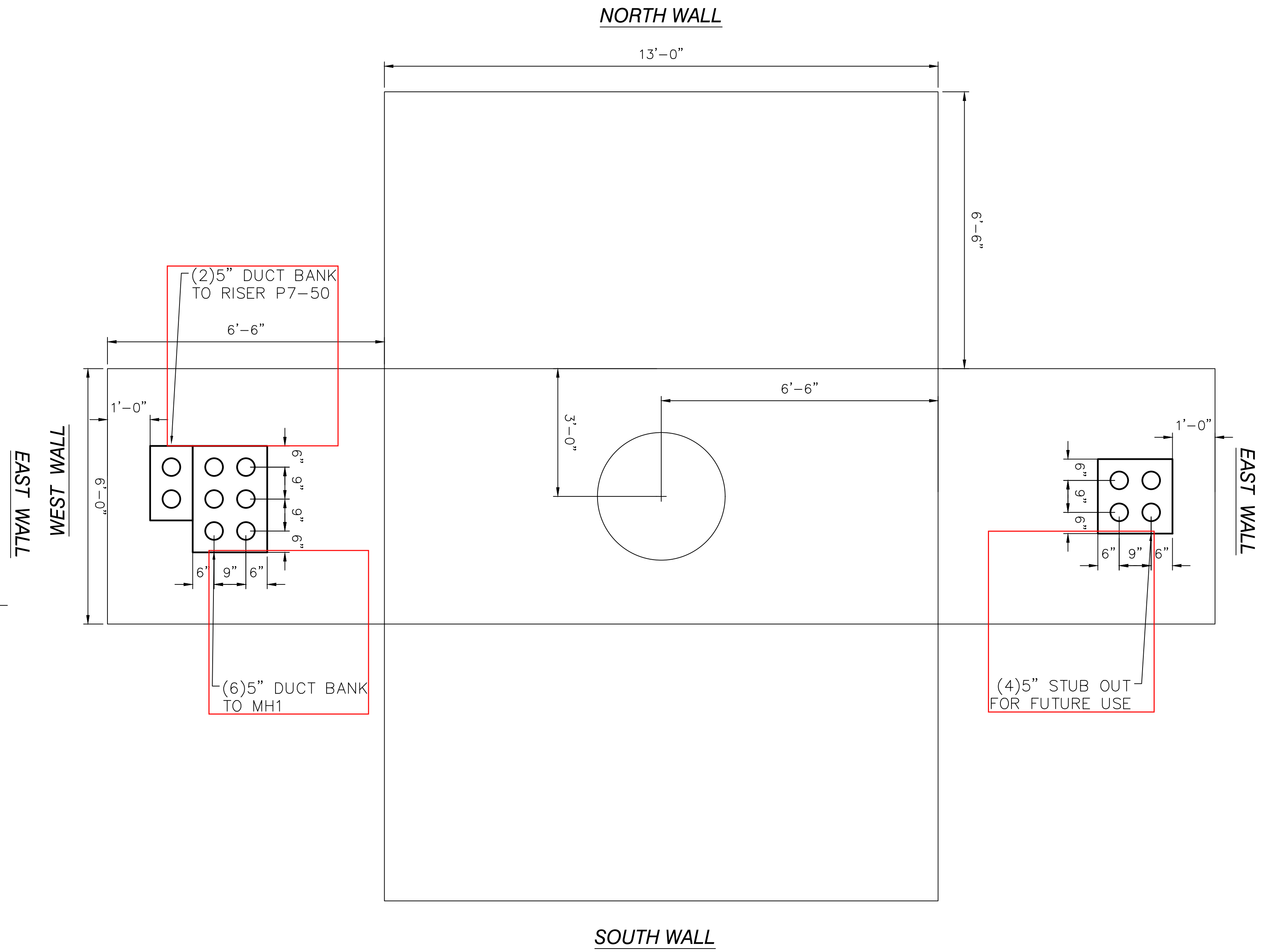

MANHOLE NUMBER: MH2

SIZE: L=13' W=6' H=6'-6"
 MANHOLE RING SIZE: 36"
 MANHOLE COVER SIZE: 26"
 CHIMNEY HEIGHT: 2'-0"

		124 Grove St. Franklin, MA 02038		PROJECT NO: 270728			
REV	DESCRIPTION	DATE	DES	CHK	APP		

DESIGNED		MASSDOT DAMON RD LAYOUT PLAN
DRAWN		
CHECKED		
APPROVED		
REVIEW 1	3/24/21	
REVIEW 2	NTS	
	SCALE	DET-1
		WR#23303524

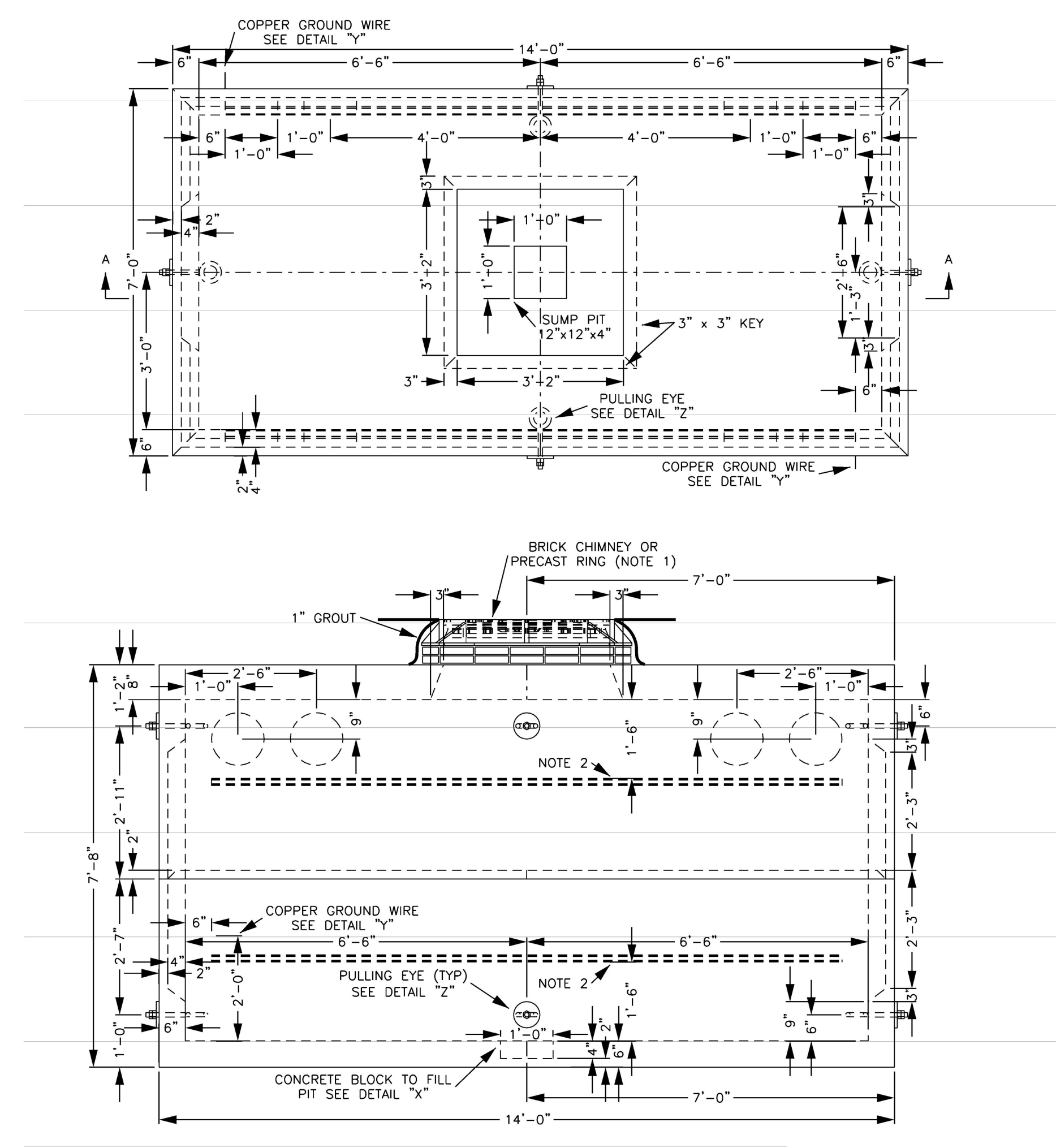
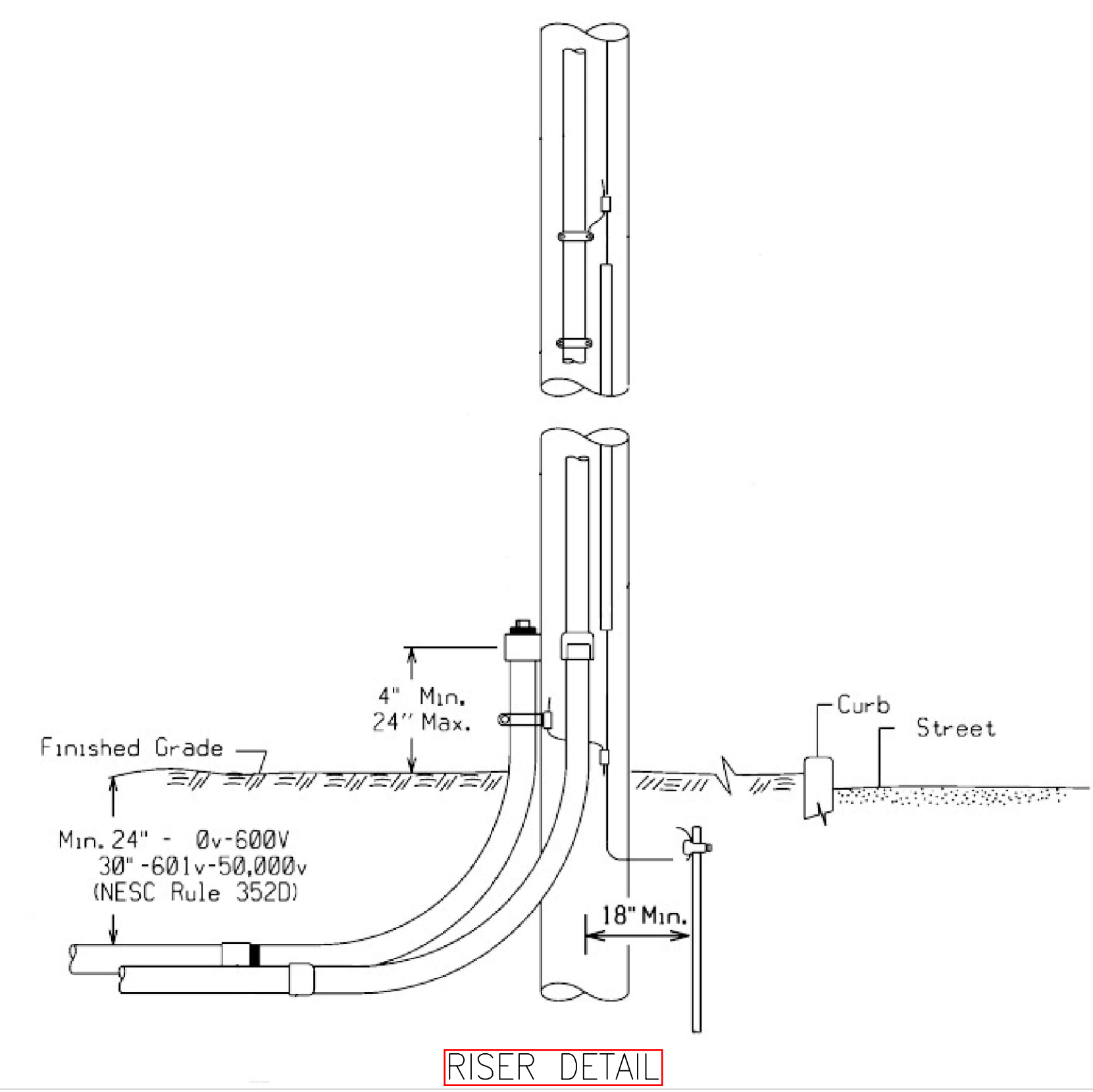
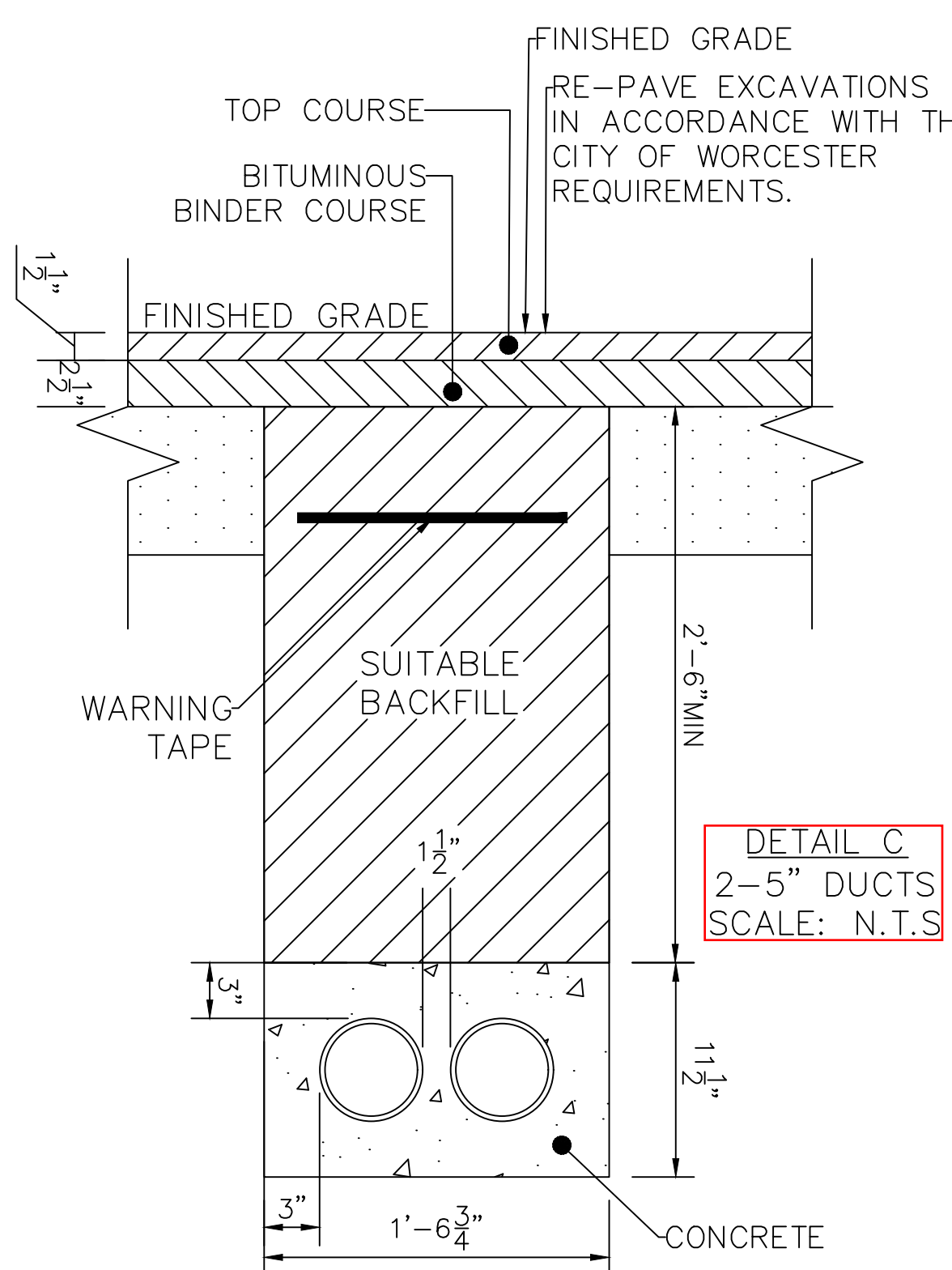
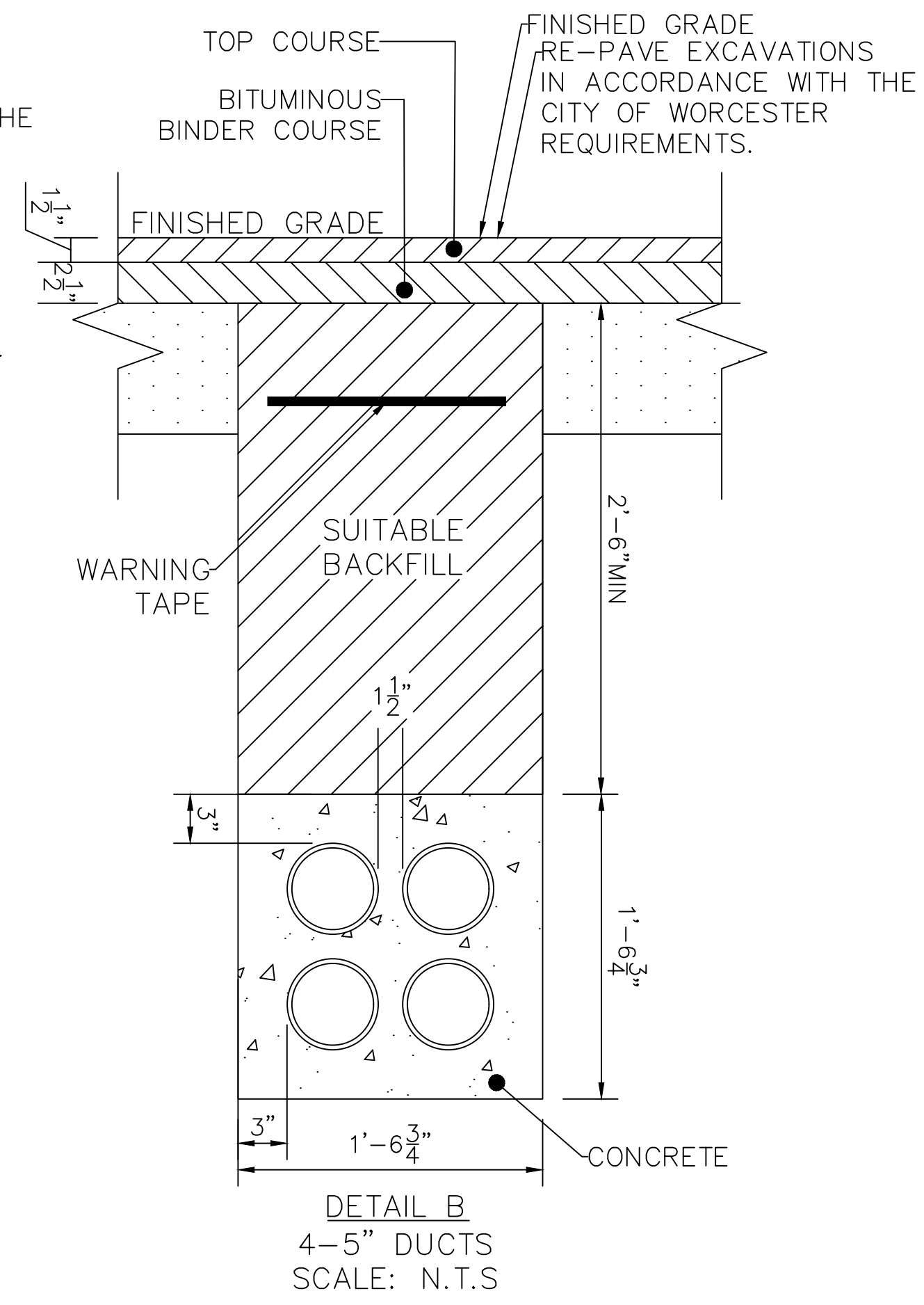
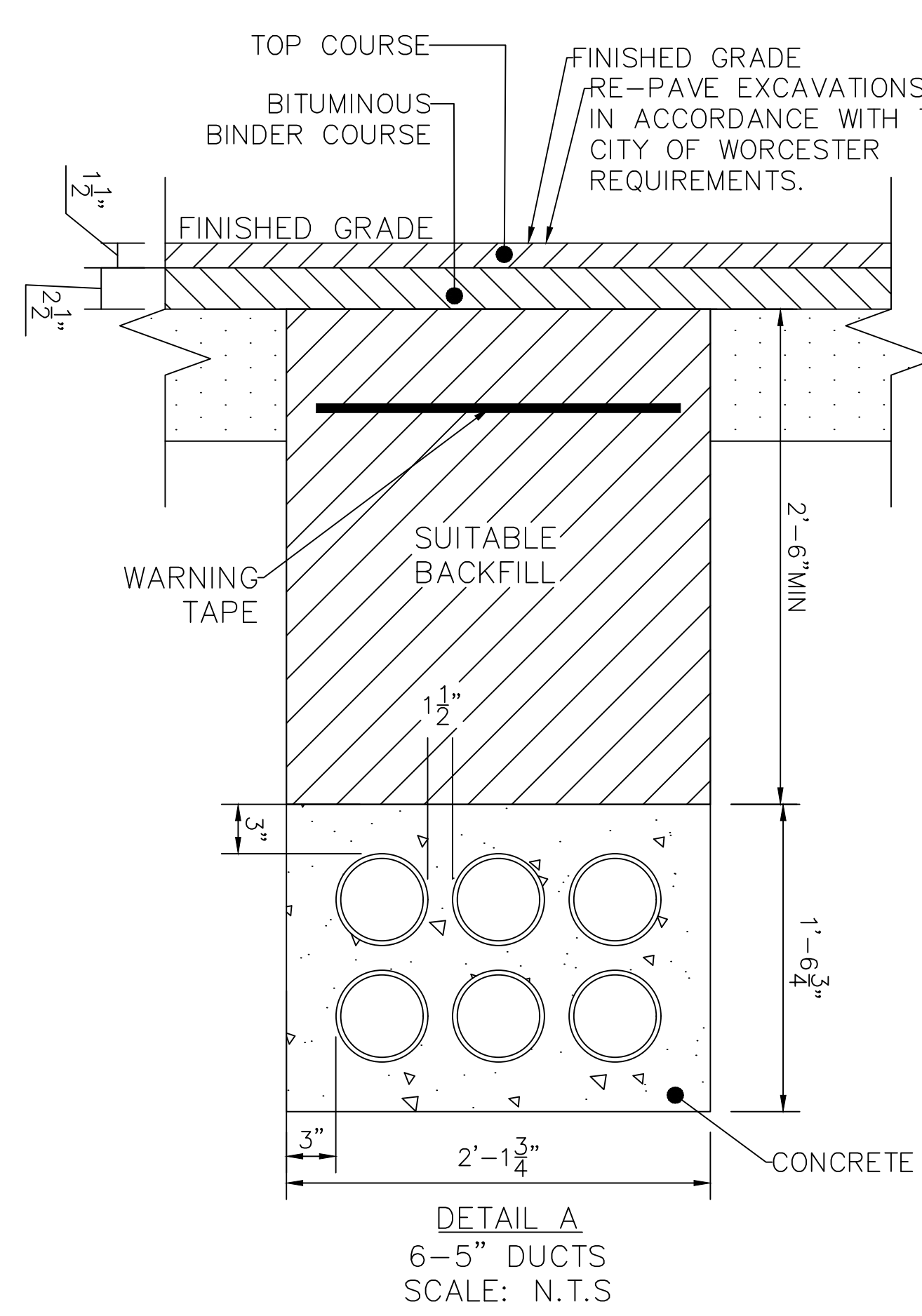

NOTE
 1. FOR MANHOLE CHIMNEY OR PRECAST RING SEE MS 3748, 3755 AND 3757. USE WITH UM14F(36" FRAME), UM14R(26"-36" RING) AND UM14C(26" COVER).
 2. INSTALL 1-3/8"x1-3/8" HEAVY DUTY GALVANIZED UNISTRUT AND CABLE POSITIONING BRACKETS. UNISTRUT NEEDS TO BE PROPERLY BONDED TO THE GROUND GRID WITH A TINNED CONNECTOR AND 4/0 CABLE.

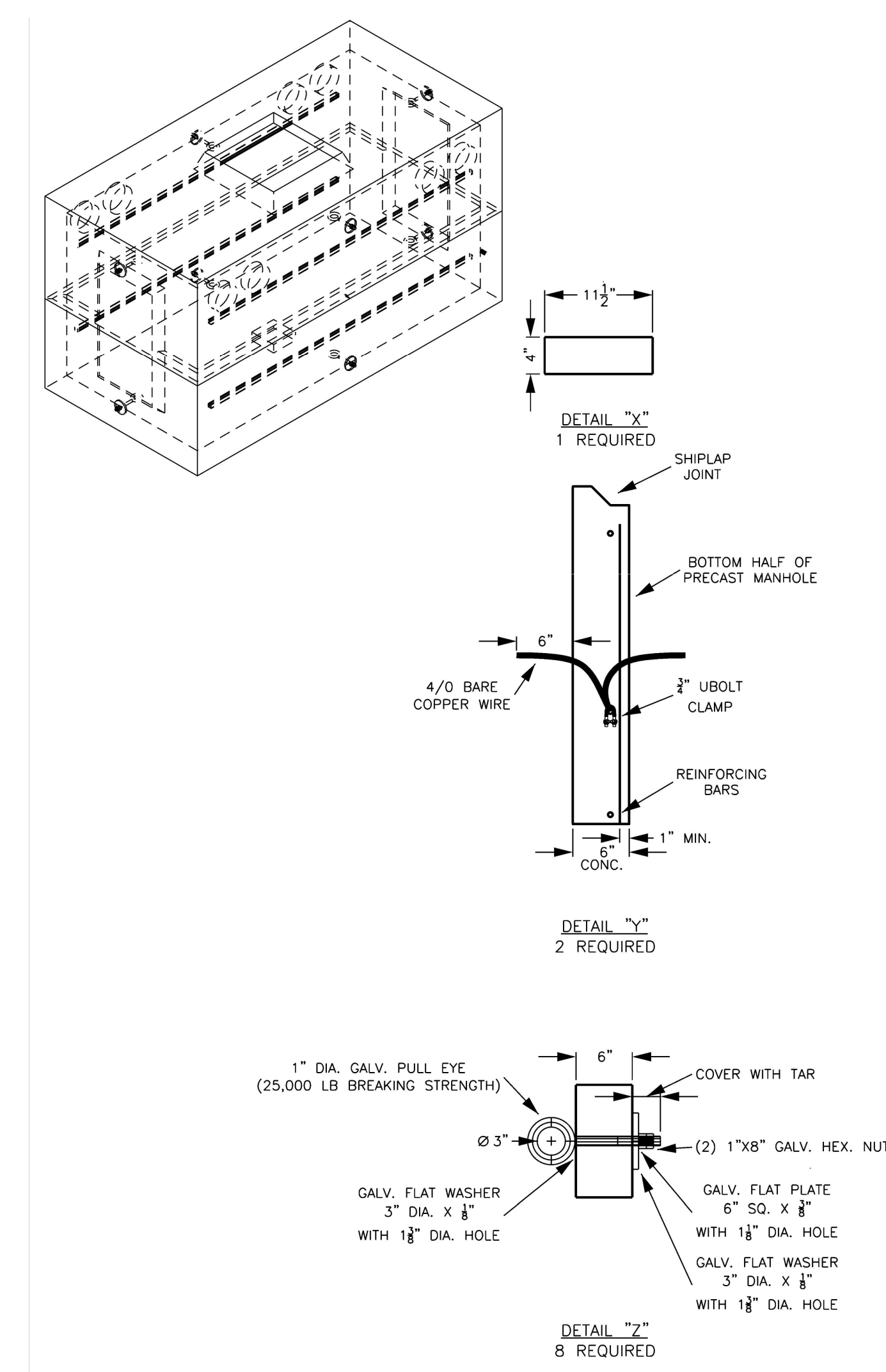

TYPICAL 2 WAY MANHOLE DETAIL

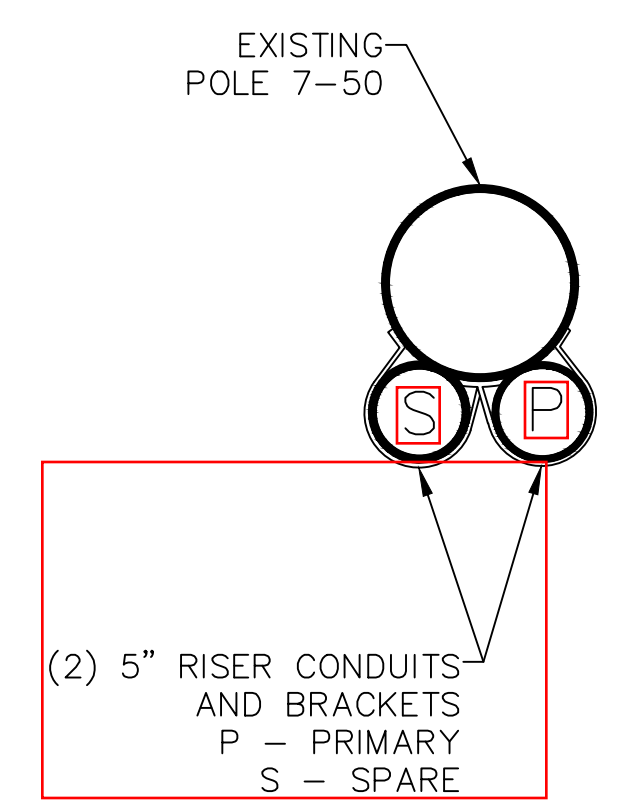
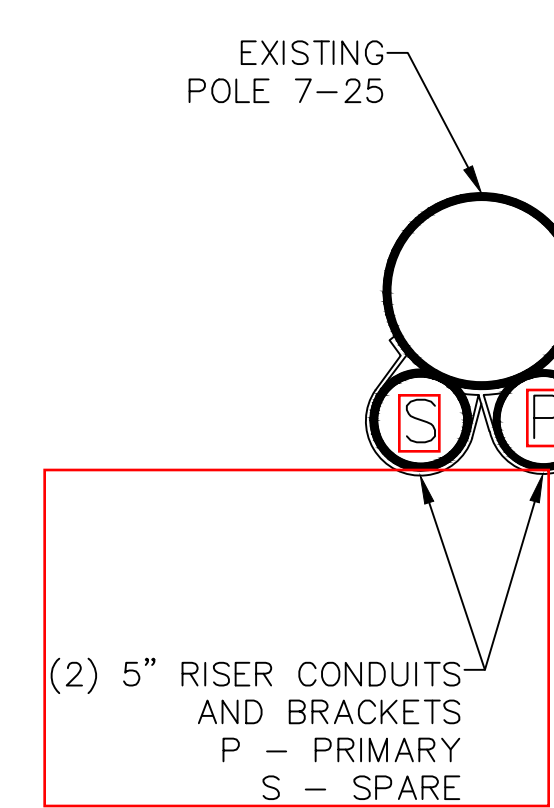

124 Grove St. Franklin, MA 02038		PROJECT NO: 270728					
REV	DESCRIPTION	DATE	DES	CHK	APP	MASSDOT DAMON RD LAYOUT PLAN	
DESIGNED	AS	CHECKED	APPROVED	REVIEW 1	DATE: 3/24/21		REV. 0
				REVIEW 2	NTS SCALE	DET-2	WR#23303524

#48 DAMON RD

18D-035-001

OWNER: KERRYMAN PARTNERSHIP

P.O. BOX 60266, FLORENCE MA 01062

PATCH EAST OF LANE PLANT ROAD

18D-057-001

OWNER: CITY OF NORTHAMPTON

210 MAIN ST, NORTHAMPTON MA 01060

#55 DAMON RD

18D-065-001

OWNER: ROBERT S. THOMAS

55 DAMON RD, NORTHAMPTON MA 01060

#137 DAMON RD

18D-005-001

OWNER: EASTHAMPTON MAHADEV LLC

8 KINSBERRY WAY, EASTHAMPTON MA 01027



April 6, 2021

City Council
Town of Northampton

To Whom It May Concern:

Enclosed please find the revised petition of NATIONAL GRID covering the installation of underground facilities.

If you have any questions regarding this permit, please contact:

Daniel Lopez-Velez 774-235-2603

If this petition meets with your approval, please return an executed copy to:

National Grid: Lisa Ayres; 1101 Turnpike Street; North Andover, MA 01845
(978)725-1418

Very truly yours,

Jim Kehrer/lla

Jim Kehrer
Name: Distribution Design Supervisor
Supervisor, Distribution Design

Enclosures

Questions contact – Daniel Lopez-Velez 774-235-2603

Petition of the Massachusetts Electric Company d/b/a NATIONAL GRID
Of NORTH ANDOVER, MASSACHUSETTS
For Electric Conduit Location:

To the City Council of Northampton, Massachusetts

Respectfully represents the Massachusetts Electric Company d/b/a NATIONAL GRID of North Andover, Massachusetts, that it desires to construct a line of underground electric conduits, including the necessary sustaining and protecting fixtures, under and across the public way or ways hereinafter named.

Wherefore it prays that after due notice and hearing as provided by law, it be granted permission to excavate the public highways and to run and maintain underground electric conduits, together with such sustaining and protecting fixtures as it may find necessary for the transmission of electricity, said underground conduits to be located substantially in accordance with the plan filed herewith marked – Damon Rd. - Northampton, Massachusetts.

The following are the streets and highways referred to: **23303524**

Damon Rd. - beginning at a point approximately 213 feet northeast of the centerline of the intersection of Industrial Dr. and Damon Rd. and continuing approximately 377 feet in a northeast direction, National Grid to install MH 1 Damon Rd., install MH 2 Damon Rd., install 45' of 2-5" Conduit from P7-25 Damon Rd to MH 1 Damon Rd., install ~377' of 6-5" Conduit from MH 1 to MH 2 Damon Rd., and install ~37' of 2-5" Conduit from P7-50 Damon Rd to MH 2 Damon Rd.

Location approximately as shown on plan attached.

Massachusetts Electric Company d/b/a
NATIONAL GRID *Jim Kehrer/lla*

BY _____
Engineering Department

Dated: April 6, 2021

ORDERED:

Notice having been given and public hearing held, as provided by law, that the Massachusetts Electric Company d/b/a NATIONAL GRID be and it is hereby granted permission to excavate the public highways and to run and maintain underground electric conduits, together with such sustaining and protecting fixtures as said company may deem necessary, in the public way or ways hereinafter referred to, and to make the necessary house connections along said extensions, as requested in petition with said company dated the 6th day of April 2021.

Said underground electric conduits shall be located substantially in accordance with the plan filed herewith marked – Damon Rd. - Northampton, Massachusetts **23303524**

The following are the public ways or part of ways along which the underground electric conduits above referred to may be laid:

Damon Rd. - beginning at a point approximately 213 feet northeast of the centerline of the intersection of Industrial Dr. and Damon Rd. and continuing approximately 377 feet in a northeast direction, National Grid to install MH 1 Damon Rd., install MH 2 Damon Rd., install 45' of 2-5" Conduit from P7-25 Damon Rd to MH 1 Damon Rd., install ~377' of 6-5" Conduit from MH 1 to MH 2 Damon Rd., and install ~37' of 2-5" Conduit from P7-50 Damon Rd to MH 2 Damon Rd.

I hereby certify that the foregoing order was adopted at a meeting of the
.....
....., held on the day of, 20

....., 20

Received and entered in the records of location orders of the City/Town of
Book Page

Attest:
.....

..... hereby certify that on20....., at o'clock,M
at, a public hearing was held on the petition of
Massachusetts Electric Company d/b/a NATIONAL GRID for permission to construct the
underground electric conduits described in the order herewith recorded, and that I mailed at least
seven days before said hearing a written notice of the time and place of said hearing to each of the
owners of real estate (as determined by the last preceding assessment for taxation) along the ways
or parts of ways upon which the Company is permitted to construct the underground electric
conduits under said order. And that thereupon said order was duly adopted.

.....
.....
.....

ORDERED:

Notice having been given and public hearing held, as provided by law, that the Massachusetts Electric Company d/b/a NATIONAL GRID be and it is hereby granted permission to excavate the public highways and to run and maintain underground electric conduits, together with such sustaining and protecting fixtures as said company may deem necessary, in the public way or ways hereinafter referred to, and to make the necessary house connections along said extensions, as requested in petition with said company dated the 6th day of April 2021.

Said underground electric conduits shall be located substantially in accordance with the plan filed herewith marked – Damon Rd. - Northampton, Massachusetts **23303524**

The following are the public ways or part of ways along which the underground electric conduits above referred to may be laid:

Damon Rd. - beginning at a point approximately 213 feet northeast of the centerline of the intersection of Industrial Dr. and Damon Rd. and continuing approximately 377 feet in a northeast direction, National Grid to install MH 1 Damon Rd., install MH 2 Damon Rd., install 45' of 2-5" Conduit from P7-25 Damon Rd to MH 1 Damon Rd., install ~377' of 6-5" Conduit from MH 1 to MH 2 Damon Rd., and install ~37' of 2-5" Conduit from P7-50 Damon Rd to MH 2 Damon Rd.

I hereby certify that the foregoing order was adopted at a meeting of the
.....
....., held on the day of, 20

....., 20

Received and entered in the records of location orders of the City/Town of
Book Page

Attest:
.....

..... hereby certify that on20....., at o'clock,M
at, a public hearing was held on the petition of
Massachusetts Electric Company d/b/a NATIONAL GRID for permission to construct the
underground electric conduits described in the order herewith recorded, and that I mailed at least
seven days before said hearing a written notice of the time and place of said hearing to each of the
owners of real estate (as determined by the last preceding assessment for taxation) along the ways
or parts of ways upon which the Company is permitted to construct the underground electric
conduits under said order. And that thereupon said order was duly adopted.

.....
.....
.....



CITY OF NORTHAMPTON, MASSACHUSETTS
DEPARTMENT OF PUBLIC WORKS
125 Locust Street
Northampton, MA 01060

413-587-1570
Fax 413-587-1576

Donna LaScaleia
Director

Memorandum

To: Donna LaScaleia, Director of Public Works *Approved M 3-23-21*
From: Felix Harvey, Staff Civil Engineer
Date: March 23, 2021
Re: Petition for Joint or Identical Pole Locations No. 30293688

National Grid is proposing to install one (1) Jointly Owned Pole on Warner Street approximately 163 feet from the centerline of the intersection with Federal Street, as staked.

The proposed pole location is acceptable, and does not conflict with any public utilities or public shade trees.

A valid Trench Permit issued by the Department of Public Works is required prior to pole installation.



March 23, 2021

The City Council of Northampton, Massachusetts

To Whom It May Concern:

Enclosed please find a revised petition of NATIONAL GRID and VERIZON, covering joint NATIONAL GRID-VERIZON pole location(s)

If you have any questions regarding this permit, please contact:

[Lisa Jasinski 413-582-7467](tel:413-582-7467)

Please notify National Grid's [Lisa Ayres](#) of the hearing date / time.

If this petition meets with your approval, please return an executed copy to each of the above-named Companies.

National Grid: Lisa Ayres; 1101 Turnpike Street; North Andover, MA 01845
978-725-1418







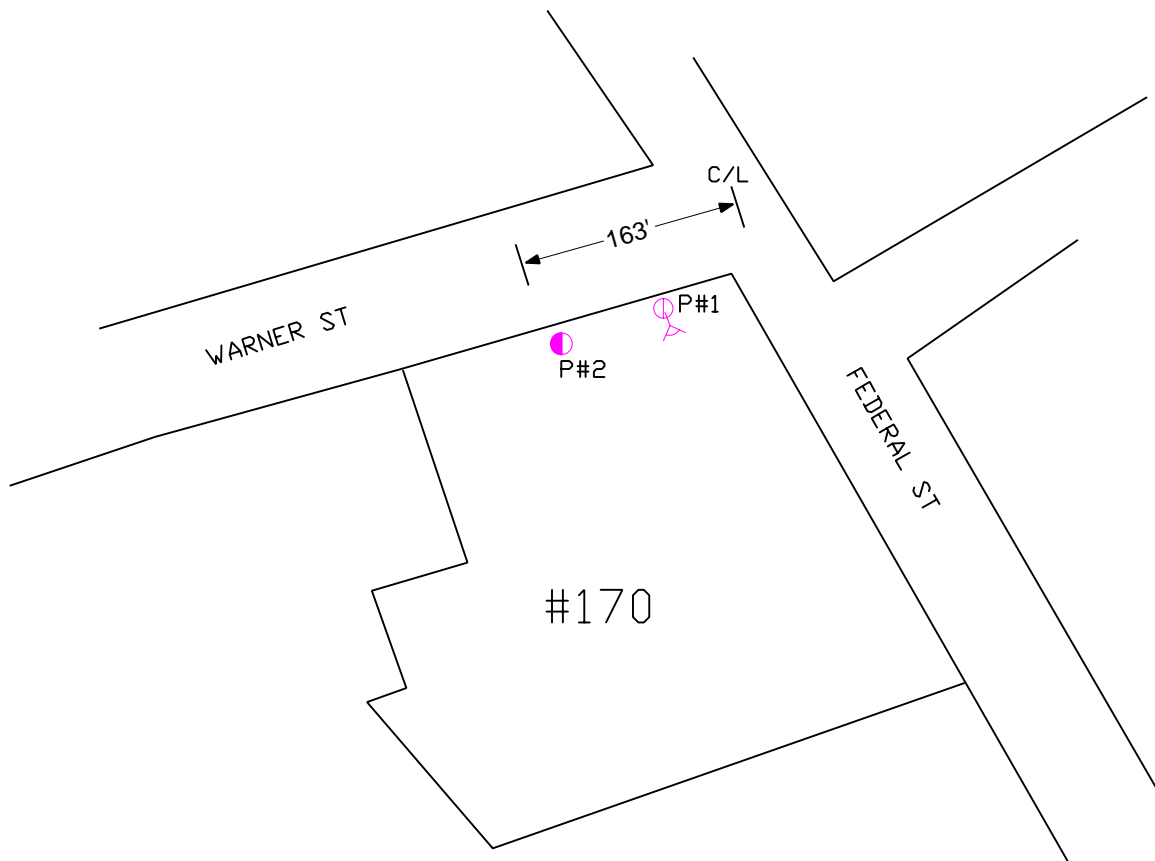
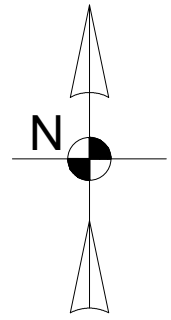

Very truly yours,

A handwritten signature in blue ink that reads "Jim Kehrer/lla".

Jim Kehrer
Supervisor, Distribution Design

Enclosures



POLE PETITION			
 Proposed NGRID Pole Locations		Date:	JANUARD 7, 2021
 Existing NGRID Pole Locations		Plan Number:	WR #30293688
 Proposed J.O. Pole Locations		To Accompany Petition Dated:	
 Existing J.O. Pole Locations		To The:	CITY Of NORTHAMPTON
 Existing Telephone Co. Pole Locations		For Proposed:	J0 Pole: 1 Location: WARNER ST
 Existing NGRID Pole Location To Be Made J.O.		Date Of Original Grant:	
 Existing Pole Locations To Be Removed			
DISTANCES ARE APPROXIMATE			

Questions contact - Lisa Jasinski 413-222-4838
PETITION FOR JOINT OR IDENTICAL POLE LOCATIONS

North Andover, Massachusetts

To the City Council
Of Northampton, Massachusetts

Massachusetts Electric Company d/b/a NATIONAL GRID and Verizon New England, Inc requests permission to locate poles, wires, and fixtures, including the necessary sustaining and protecting fixtures, along and across the following public way:

Warner St. - National Grid to install (1) JO pole on Warner St. beginning at a point approximately 163 feet west of the centerline of the intersection of Federal St. to provide service for 2 new homes.

Location approximately as shown on plan attached.

Wherefore it prays that after due notice and hearing as provided by law, it be granted a location for and permission to erect and maintain poles and wires, together with such sustaining and protecting fixtures as it may find necessary, said poles to be erected substantially in accordance with the plan filed herewith marked – Warner St. - Northampton, Massachusetts.

30293688

Also, for permission to lay and maintain underground laterals, cables, and wires in the above or intersecting public ways for the purpose of making connections with such poles and buildings as each of said petitioners may desire for distributing purposes.

Your petitioner agrees to reserve space for one cross-arm at a suitable point on each of said poles for the fire, police, telephone, and telegraph signal wires belonging to the municipality and used by it exclusively for municipal purposes.

Massachusetts Electric Company d/b/a

NATIONAL GRID *Jim Kehrer/lla*

BY _____

Engineering Department

VERIZON NEW ENGLAND, INC.

BY _____

Manager / Right of Way

Dated: March 23, 2021

Questions contact – Lisa Jasinski 413-222-4838

ORDER FOR JOINT OR IDENTICAL POLE LOCATIONS

To the City Council - Northampton, Massachusetts

Notice having been given and public hearing held, as provided by law,
IT IS HEREBY ORDERED:

that Massachusetts Electric Company d/b/a NATIONAL GRID and VERIZON NEW ENGLAND INC. (formerly known as NEW ENGLAND TELEPHONE AND TELEGRAPH COMPANY) be and they are hereby granted joint or identical locations for and permission to erect and maintain poles and wires to be placed thereon, together with such sustaining and protecting fixtures as said Companies may deem necessary, in the public way or ways hereinafter referred to, as requested in petition of said Companies dated the 23rd day of March 2021.

All construction under this order shall be in accordance with the following conditions:

Poles shall be of sound timber, and reasonable straight, and shall be set substantially at the points indicated upon the plan marked – Warner St. - Northampton, Massachusetts.

30293688 Filed with this order:

There may be attached to said poles by Massachusetts Electric Company d/b/a NATIONAL GRID and Verizon New England Inc. such wires, cables, and fixtures as needed in their business and all of said wires and cables shall be placed at a height of not less than twenty (20) feet from the ground.

The following are the public ways or part of ways along which the poles above referred to may be erected, and the number of poles which may be erected thereon under this order:

Warner St. - National Grid to install (1) JO pole on Warner St. beginning at a point approximately 163 feet west of the centerline of the intersection of Federal St. to provide service for 2 new homes.

Also, for permission to lay and maintain underground laterals, cables, and wires in the above or intersecting public ways for the purpose of making connections with such poles and buildings as each of said petitioners may desire for distributing purposes.

I hereby certify that the foregoing order was adopted at a meeting of the
Of the City/Town of _____, Massachusetts held on the _____ day of _____ 20__ .

Massachusetts City/Town Clerk.
20__ .

Received and entered in the records of location orders of the City/Town of
Book _____ Page _____

Attest:
City/Town Clerk

I hereby certify that on _____ 20____, at _____ o'clock, M
At _____ a public hearing was held on the petition of
Massachusetts Electric Company d/b/a NATIONAL GRID and VERIZON NEW ENGLAND,
INC. for permission to erect the poles, wires, and fixtures described in the order herewith recorded,
and that we mailed at least seven days before said hearing a written notice of the time and place of
said hearing to each of the owners of real estate (as determined by the last preceding assessment
for taxation) along the ways or parts of ways upon which the Company is permitted to erect
Poles, wires, and fixtures under said order. And that thereupon said order was duly adopted.

City/Town Clerk.

.....
.....
.....
.....

Board or Council of Town or City, Massachusetts

CERTIFICATE

I hereby certify that the foregoing is a true copy of the location order and certificate of
hearing with notice adopted by the _____ of the City of
Massachusetts, on the _____ day of 20____ and recorded with the records of location orders
of the said City, Book _____, and Page _____. This certified copy is made under the
provisions of Chapter 166 of General Laws and any additions thereto or amendments thereof.

Attest:
City/Town Clerk

Questions contact – Lisa Jasinski 413-222-4838

ORDER FOR JOINT OR IDENTICAL POLE LOCATIONS

To the City Council - Northampton, Massachusetts

Notice having been given and public hearing held, as provided by law,
IT IS HEREBY ORDERED:

that Massachusetts Electric Company d/b/a NATIONAL GRID and VERIZON NEW ENGLAND INC. (formerly known as NEW ENGLAND TELEPHONE AND TELEGRAPH COMPANY) be and they are hereby granted joint or identical locations for and permission to erect and maintain poles and wires to be placed thereon, together with such sustaining and protecting fixtures as said Companies may deem necessary, in the public way or ways hereinafter referred to, as requested in petition of said Companies dated the 23rd day of March 2021.

All construction under this order shall be in accordance with the following conditions:

Poles shall be of sound timber, and reasonable straight, and shall be set substantially at the points indicated upon the plan marked – Warner St. - Northampton, Massachusetts.

30293688 Filed with this order:

There may be attached to said poles by Massachusetts Electric Company d/b/a NATIONAL GRID and Verizon New England Inc. such wires, cables, and fixtures as needed in their business and all of said wires and cables shall be placed at a height of not less than twenty (20) feet from the ground.

The following are the public ways or part of ways along which the poles above referred to may be erected, and the number of poles which may be erected thereon under this order:

Warner St. - National Grid to install (1) JO pole on Warner St. beginning at a point approximately 163 feet west of the centerline of the intersection of Federal St. to provide service for 2 new homes.

Also, for permission to lay and maintain underground laterals, cables, and wires in the above or intersecting public ways for the purpose of making connections with such poles and buildings as each of said petitioners may desire for distributing purposes.

I hereby certify that the foregoing order was adopted at a meeting of the
Of the City/Town of _____, Massachusetts held on the _____ day of _____ 20 ____ .

Massachusetts City/Town Clerk.
20 ____ .

Received and entered in the records of location orders of the City/Town of
Book _____ Page _____

Attest:
City/Town Clerk

I hereby certify that on _____ 20____, at _____ o'clock, M
At _____ a public hearing was held on the petition of
Massachusetts Electric Company d/b/a NATIONAL GRID and VERIZON NEW ENGLAND,
INC. for permission to erect the poles, wires, and fixtures described in the order herewith recorded,
and that we mailed at least seven days before said hearing a written notice of the time and place of
said hearing to each of the owners of real estate (as determined by the last preceding assessment
for taxation) along the ways or parts of ways upon which the Company is permitted to erect
Poles, wires, and fixtures under said order. And that thereupon said order was duly adopted.

City/Town Clerk.

.....
.....
.....
.....

Board or Council of Town or City, Massachusetts

CERTIFICATE

I hereby certify that the foregoing is a true copy of the location order and certificate of
hearing with notice adopted by the _____ of the City of
Massachusetts, on the _____ day of 20____ and recorded with the records of location orders
of the said City, Book _____, and Page _____. This certified copy is made under the
provisions of Chapter 166 of General Laws and any additions thereto or amendments thereof.

Attest:
City/Town Clerk

Questions contact – Lisa Jasinski 413-222-4838

ORDER FOR JOINT OR IDENTICAL POLE LOCATIONS

To the City Council - Northampton, Massachusetts

Notice having been given and public hearing held, as provided by law,
IT IS HEREBY ORDERED:

that Massachusetts Electric Company d/b/a NATIONAL GRID and VERIZON NEW ENGLAND INC. (formerly known as NEW ENGLAND TELEPHONE AND TELEGRAPH COMPANY) be and they are hereby granted joint or identical locations for and permission to erect and maintain poles and wires to be placed thereon, together with such sustaining and protecting fixtures as said Companies may deem necessary, in the public way or ways hereinafter referred to, as requested in petition of said Companies dated the 23rd day of March 2021.

All construction under this order shall be in accordance with the following conditions:

Poles shall be of sound timber, and reasonable straight, and shall be set substantially at the points indicated upon the plan marked – Warner St. - Northampton, Massachusetts.

30293688 Filed with this order:

There may be attached to said poles by Massachusetts Electric Company d/b/a NATIONAL GRID and Verizon New England Inc. such wires, cables, and fixtures as needed in their business and all of said wires and cables shall be placed at a height of not less than twenty (20) feet from the ground.

The following are the public ways or part of ways along which the poles above referred to may be erected, and the number of poles which may be erected thereon under this order:

Warner St. - National Grid to install (1) JO pole on Warner St. beginning at a point approximately 163 feet west of the centerline of the intersection of Federal St. to provide service for 2 new homes.

Also, for permission to lay and maintain underground laterals, cables, and wires in the above or intersecting public ways for the purpose of making connections with such poles and buildings as each of said petitioners may desire for distributing purposes.

I hereby certify that the foregoing order was adopted at a meeting of the
Of the City/Town of _____, Massachusetts held on the _____ day of _____ 20__ .

Massachusetts City/Town Clerk.
20__ .

Received and entered in the records of location orders of the City/Town of
Book _____ Page _____

Attest:
City/Town Clerk

I hereby certify that on _____ 20____, at _____ o'clock, M
At _____ a public hearing was held on the petition of
Massachusetts Electric Company d/b/a NATIONAL GRID and VERIZON NEW ENGLAND,
INC. for permission to erect the poles, wires, and fixtures described in the order herewith recorded,
and that we mailed at least seven days before said hearing a written notice of the time and place of
said hearing to each of the owners of real estate (as determined by the last preceding assessment
for taxation) along the ways or parts of ways upon which the Company is permitted to erect
Poles, wires, and fixtures under said order. And that thereupon said order was duly adopted.

City/Town Clerk.

.....
.....
.....
.....

Board or Council of Town or City, Massachusetts

CERTIFICATE

I hereby certify that the foregoing is a true copy of the location order and certificate of
hearing with notice adopted by the _____ of the City of
Massachusetts, on the _____ day of 20____ and recorded with the records of location orders
of the said City, Book _____, and Page _____. This certified copy is made under the
provisions of Chapter 166 of General Laws and any additions thereto or amendments thereof.

Attest:
City/Town Clerk



City of Northampton

MASSACHUSETTS

In the City Council, April 1, 2021

Upon the Recommendation of: Councilor Karen Foster
 Councilor Rachel Maiore
 Councilor Alex Jarrett

R-21.231

A RESOLUTION DECLARING A CLIMATE EMERGENCY

WHEREAS, in a world facing the extreme challenges of rapid climate change, Northampton residents understand the importance of protecting the Earth and its inhabitants; can envision a better, sustainable future; and can create and execute bold plans for a prosperous economy and a thriving community; and

WHEREAS, progress toward this future is underway in Massachusetts, which is among national leaders on climate initiatives with over 100,000 jobs in the state's clean energy sector¹ and named a top energy efficient state for the past decade by the American Council for an Energy-Efficient Economy; and

WHEREAS, Northampton has an engaged City government and has undertaken a number of important steps on climate and the environment, (such as the Sustainable Northampton Comprehensive Plan and the Climate Resilience and Regeneration Plan), such that the City is well placed to implement the critical transition away from fossil fuels and to advance a robust, carbon-free, equitable economy and the improved health and quality of life that will result; and

WHEREAS, on April 22, 2016, world leaders from 175 countries recognized the threat of climate change and the urgent need to combat it by signing the Paris Agreement, agreeing to keep warming "well below 2°C above pre-industrial levels" and to "pursue efforts to limit the temperature increase to 1.5°C" and Mayor David J. Narkewicz committed to the Paris Accord on behalf of Northampton; and

¹O'Brien, Kelly J. "Clean energy jobs top 100,000 for first time in Mass., according to new report," *Boston Business Journal*. Dec. 15, 2016. <https://www.bizjournals.com/boston/news/2016/12/15/clean-energy-jobs-top-100-000-for-first-time-in.html>

WHEREAS, marginalized populations in the Commonwealth of Massachusetts and worldwide, including people of color, immigrants, indigenous communities, low-income individuals, people with disabilities, and the unhoused are already disproportionately affected by climate change, and will continue to bear an excessive burden as temperatures increase, oceans rise, and natural disasters worsen; and

WHEREAS, nearly 400 cities, districts and counties across the world collectively representing over 34 million people have recently declared or officially acknowledged the existence of a global Climate Emergency, including over 20 Massachusetts cities and towns such as Boston, Lexington, Acton, and 11 towns on Cape Cod; and

WHEREAS, declaring the climate crisis as an emergency is a crucial first step for aligning residents around the urgency of the global climate breakdown; and

WHEREAS, declaring that the climate crisis is an emergency demonstrates that our government agencies acknowledge that addressing climate change will require an emergency response at emergency speed; and

WHEREAS, the crisis caused by climate change also presents a major opportunity to invest in healthy energy, transportation, land-use, and agriculture systems that will deliver both immediate and sustained benefits to all and reduce future risks from climate change;

NOW, THEREFORE BE IT RESOLVED, that the City Council of Northampton affirms that human activity caused the climate crisis and that fossil fuels are the primary cause;

BE IT FURTHER RESOLVED that the City Council of Northampton hereby declares that a Climate Emergency threatens our city, state, and nation, as well as humanity broadly, and that a mobilization to meet this challenge is both a moral imperative and an unprecedented opportunity to stabilize the climate, remedy environmental harms, create clean-energy jobs, and improve human lives.

BE IT FURTHER RESOLVED that the members of the Northampton City Council call on City government and staff and all Northampton civic groups, businesses, and residents to commit to a climate mobilization effort to bring net City-wide carbon emissions to zero no later than the year 2050, though we advocate for increased state and federal assistance so that we can aim for carbon neutrality by 2030;

BE IT FURTHER RESOLVED that the City of Northampton's climate mobilization should also: (1) accelerate adaptation and resilience strategies in preparation for intensifying local and global climate impacts; (2) continue to protect trees, forests, and other open spaces because of their ability to draw carbon out of the atmosphere and store it; (3) protect the habitats and corridors of wildlife that are vulnerable to the impacts of climate change; and (4) ensure that the costs of such mobilization efforts do not unfairly burden those who are economically or socially disadvantaged and that the benefits of a realized, sustainable future accrue to all.

BE IT FURTHER RESOLVED that the Administrative Assistant to the City Council shall send a copy of this Resolution to Representative Lindsay Sabadosa and Senator Jo Comerford, as well as Governor Charles Baker, DOER Commissioner Patrick Woodcock, and the Co-Chairs and Vice Co-Chairs of the Joint Committee on Telecommunications, Utilities, and Energy, Senators Mike Barrett and Mark Pacheco and Representatives Jeffrey Roy and Paul Mark.



CITY OF NORTHAMPTON

MASSACUSETTS

In the City Council, April 1, 2021

Upon the Recommendation of: Councilor William Dwight

21.233 A Resolution to Review and Revise the Rules and Committees of the City Council

Whereas, the City Council of Northampton, on a regular basis and as the need arises, must review and revise the rules that prescribe the processes by which the body shall deliberate; and

Whereas, the City Council must also periodically reconsider and evaluate the Committees of the Council to determine how they may best serve the Council; and

Whereas, the COVID 19 pandemic required significant changes in the way the Council convenes and conducts its business; and

Whereas, the Open Meeting Law of the Commonwealth requirements continue to evolve in meaningful ways as the Council conducts its business remotely via a changing technology; and

Whereas, the City Council of Northampton abides by and upholds the principles and the spirit of open government; and

Whereas, some Council rules have been rendered outdated and void by recent decisions by the Attorney General and the Governor in order to allow safe participation and continuity in government;

Now therefore, be it resolved that: the City Council requests that the Council President appoint a select committee dedicated to the review of the Council Rules and Council Committees to assemble at a time determined by the President; and

Be it further resolved that, the Committee shall deliver to the Council, at a time determined by the President, recommendations to be considered; and

Be it further resolved that, the President shall determine the members of the Committee which may include individuals who are not City Councilors.

MEMBERS

Councilor John Thorpe, Chair
Megan Paik, Citizen, Vice-Chair
Councilor Jim Nash
Councilor Marianne LaBarge
Jeff Napolitano, Citizen



Report of the 2020 Special Committee for Review of Ordinances

Summary of Recommendations

The Special Committee for Review of Ordinances (“the Committee”) submits this Report of its 2020 review of the ordinances of the City of Northampton in accordance with Northampton Code of Ordinances, § 1-15.1. That section was adopted pursuant to the Northampton Special Act Charter (“the Charter”), § 10-6. Section 1-15.1 requires review of ordinances every five years in years ending in a 5 or in a 0. While the ordinance requires a report to be filed by December 31st of such years, the Northampton City Council voted on December 3, 2020 to extend that date to March 31, 2021 on account of the Committee’s delayed formation due to the novel coronavirus pandemic of 2020. The Committee was appointed on September 3, 2020, and it was comprised of three members of the City Council appointed by the Council President and two voters of the City appointed by the Mayor. The Committee met under the supervision of the City Solicitor. It held 15 virtual meetings by Zoom on September 30, 2020, October 19, 2020, November 2, 2020, November 17, 2020, November 30, 2020, December 7, 2020, December 15, 2020, January 4, 2021, January 11, 2021, February 1, 2021, February 22, 2021, March 1, 2021, March 15, 2021, March 23, 2021, and March 29, 2021.

An “ordinance,” as that term is used in the Charter and in Section 1-15.1, has a very specific meaning. It is a legislative act that has the force of law and binds the City and all persons within the jurisdictional limits of the City. The authority of the City Council to pass an ordinance is found either in State law or in the Charter. Ordinances must be distinguished from a Resolution of the Council which is a current statement of the Council’s position on a certain issue that has no force of law.

On September 3, 2020, the City Council adopted **20.107 A Resolution in Support of Actions to Combat the Public Health Crisis of Systemic Racism**, which stated in part:

We have an obligation to advance racial equity by undoing the inequities found in the law, and to proactively pass ordinances and make budget decisions that address inequity. During the Periodic Review of Ordinances which occurs every 5 years as per the City Charter Section 10-5, and at other times when it comes to the attention of the Council, we will act to update ordinances that have been shown to have a disproportionate impact on communities of color and adversely affect marginalized populations. We will also consider these impacts during our annual budget process and as financial orders are brought to the Council.

The Committee accepted this Resolution as the guiding principle of its focus on the City’s ordinances. Marginalized populations of Northampton, in our deliberations and reporting, include but are not limited to residents who are people of color, low-income, housing-insecure, and/or disabled who experience systemic inequities of residential segregation, intergenerational wealth inequality, and access to public services.

Consequently, the Committee prioritized select categories of ordinances referenced in reports produced by the National League of Cities, The National Low-Income Housing Coalition, National Housing Law Project, and others:

- zoning;
- rental housing;
- parking;
- nuisance laws; and
- land ownership.

The Committee solicited input on existing ordinances and any proposed new ordinances from all City departments, the City Councilors, and from the public. There was an opportunity for public comment at all meetings. The approved minutes of all meetings as well as all documents that were considered by the Committee are available in the city clerk's office and on the city's website.

The Committee received testimony and documents from the Office of Planning and Sustainability, the Northampton Housing Partnership, and from members of the public regarding existing and proposed ordinances that would promote the interests of historically marginalized communities, some of which the Committee voted to recommend that the City adopt and some that the Committee did not recommend. Those proposed ordinances and amendments and the Committee's recommendations are attached as Exhibit A.

The Committee also solicited from all City departments and from the public more minor recommendations of a "housekeeping" nature. Those recommendations are attached as Exhibit B.

In addition to the proposed ordinance revisions and additions submitted with this Report, the Committee voted to urge the City to study and develop amendments to zoning and other ordinances as set forth in Exhibit C. The Committee also encourages the City to address barriers to fair housing¹ in the City and to explore ways to incentivize the creation of both affordable market-rate and subsidized affordable housing.

At the same time, as explained by the City Solicitor and as further delineated in the Exhibits that follow, the subject matter of certain proposed ordinances that impact disadvantaged communities were deemed outside the legislative authority of the City Council based either on state law or on the Charter. To the extent that such matters as hiring and employment and purchasing and contracting are within the exclusive jurisdiction of the executive branch of government and not within the Committee's charge, the Committee calls upon the current Mayor and future Mayors to study and implement departmental policies in full partnership with their advisory boards and committees. Furthermore, the Committee calls upon the executive and legislative branches to examine the disparate impacts on people of color and other adversely affected marginalized communities in all their practices and procedures.

Finally, the ordinance review process contemplated in the Charter and in Section 1-15.1 is, by its terms, limited in time and its scope. Reversing the ongoing marginalization of certain

¹ By "fair housing," the Committee is referring both to the interests protected under the Fair Housing Act, which include protection from discrimination when renting or buying a home, getting a mortgage, seeking housing assistance, or engaging in other housing-related activities and fairness in the more colloquial sense, including enacting ordinances relative to housing set forth in Exhibit A.

communities is a task that exceeds the bounds of this process. The Committee calls upon the City Council to study these issues through its committee process and to alleviate the inequities that are so entrenched in our society with ordinances that fall within its jurisdiction.

The Committee looks forward to addressing its work and the recommendations contained in this Report before the City Council at such time as the Council may designate.

Respectfully submitted,

Special Committee for Review of Ordinances

By _____
City Councilor John Thorpe, Chair

Dated: March 31, 2021

Report of the 2020 Special Committee for Review of Ordinances

Exhibit A

Ordinances Impacting Historically Marginalized Communities Recommended for Adoption

1. Housing Stability Notification Ordinance.

On November 17, 2020, Keith Benoit, CDGB Planner in the Office of Planning and Sustainability, and Carmen Junno, a Member of the Northampton Housing Partnership, appeared before the Committee. They presented testimony regarding a proposed new ordinance that would require landlords of rental units or lenders foreclosing on a house to provide a list of financial and legal resources when serving a Notice to Quit terminating a tenancy or when serving foreclosure documents.¹ Such notification may include documents such as Residential Assistance for Families in Transition (RAFT) and Emergency Rental and Mortgage Assistance (ERMA). Similar ordinances have been enacted in Cambridge and Somerville. On March 1, 2021, the Committee voted unanimously to recommend that the City adopt such a Housing Stability Notification Ordinance.

2. An Ordinance Relative to Affordable Housing.

On November 2, 2020, Wayne Feiden, Director of Department of Planning and Sustainability appeared before the Committee. He testified regarding a proposed amendment to the Zoning Ordinance to create a local Affordable Housing Ordinance that would simplify the state comprehensive permit process, known as “40B.” At that time, the proposed ordinance was in its conceptual stage. On March 1, 2021, the Committee voted unanimously to recommend that the City adopt such an ordinance to promote housing affordability in the City.

3. Two-Family By Right in all Residential Districts.

On November 2, 2020, Director Feiden testified regarding a proposed amendment to the Zoning Ordinance to allow two-family residences by right in all residential zoning districts, including two detached single-family structures. At that time, the proposed ordinance had been introduced to the City Council and it was being reviewed by Council committees. On March 1, 2021, the Committee voted unanimously to recommend that the City adopt that zoning ordinance amendment to promote housing affordability in the City.

¹ The Committee is cognizant of both the time it takes to move new ordinances through committees and the prospect of the federal and state eviction and foreclosure moratoria ending in the near future. The Committee recognizes the important work that the Northampton Housing Partnership and the Office of Planning and Sustainability have performed in compiling the resources for the proposed notification ordinance, and it urges that those resources be kept current, and that the City implement administratively the notifications that were proposed to be required of landlords and mortgagees by the recommended ordinance.

4. First Floor Residential Use in Downtown and Florence Center.

On November 2, 2020, Director Feiden testified regarding a proposed amendment to the Zoning Ordinance to allow residences on first floors in in Downtown Northampton (outside of the Central Business District) and in Florence Center (outside the Chestnut/Main/Maple business district). At that time, the proposed ordinance was in the drafting stage. Allowing residential uses on the first floor of commercial buildings outside core downtown areas would allow more people to live within walking distance of commercial centers, allow property owners more options, and create housing opportunities at all levels of the market. At that time, the proposed ordinance was in its conceptual stage. On March 1, 2021, the Committee voted unanimously to recommend that the City adopt such an ordinance to promote housing affordability in the City.

**Ordinances Impacting Historically Marginalized Communities
Not Recommended for Adoption**

1. Enforcement of “Ban the Box” Law.

On November 17, 2020, Tay Porco addressed the Committee during public comment urging the City to enforce the so-called Ban the Box law, which prohibits employers from inquiring into certain aspects of an employment applicant’s criminal history. The Ban the Box law is included in a statute that prohibits discrimination in employment, and it is enforceable by the Massachusetts Commission Against Discrimination, not by the City. On that basis, on March 1, 2021, the Committee voted unanimously not to recommend the adoption of such an ordinance.

2. Ordinance Legalizing Temporary Structures and to Repeal Ordinances Prohibiting Camping on Public Property.

On November 17, 2020, Tay Porco addressed the Committee during public comment and presented a demand that the City pass an ordinance legalizing temporary structures and repealing ordinances prohibiting camping on public property. On December 15, 2020, Councilor Nash reported that his review of the ordinances did not reveal any that prohibited camping on public land other than conservation land. On March 1, 2021, the Committee unanimously voted not to recommend any such ordinances. At the same time, the Committee voted to inform the City that it would oppose any ordinance that would impede those who choose to live outdoors.

3. Fair Chance Ordinance.

In a November 18, 2020 email, Tay Porco urged the Committee to recommend an ordinance that would prohibit landlords from accessing and using the criminal history when screening a proposed tenant. While the Committee believed that such an ordinance would mitigate discriminatory practices in the housing market, City Solicitor Seewald

advised the Committee that the Criminal Offender Record Information (CORI) statute, M.G. L. c. 6, § 167, et. seq., is a comprehensive state law that creates uniform access to criminal history information statewide. The CORI statute was amended a short time ago to specifically allow landlords to access such information and, therefore, the City cannot legislate in this area. On that basis, on March 1, 2021, the Committee voted unanimously not to recommend the adoption of such an ordinance.

4. Ordinance Banning Sale of Property Gifted to City.

In the November 18, 2020 email, Tay Porco also proposed to the Committee an ordinance to ban the sale to private parties of property gifted to the City, and instead to use such property for affordable housing. Solicitor Seewald informed the Committee that the properties they cited in the email were not gifted to the city and that the city properties sold during his years as City Solicitor were sold for some form of public benefit or to meet a community need. City buildings for sale were municipal buildings not set up to comply with sanitary code and other requirements for use as housing. On March 1, 2021, the Committee voted unanimously not to recommend such an ordinance.

5. Ordinance Incentivizing Against Long-Term Vacancies in Private Properties.

In the November 18, 2020 email, Tay Porco also proposed to penalize and incentivize against vacancies in private properties. Tay cited the fact that properties remain vacant for long periods of time while unhoused individuals live on the street. Without more specific proposals for limiting the rights of private property owners or involuntary acquisition of such properties, Solicitor Seewald could not provide an opinion on the legality of such an ordinance. On March 1, 2021, the Committee voted unanimously not to recommend such an ordinance.

6. Repeal of Anti-Panhandling Ordinances.

On November 30, 2020, Razi Beresin-Scher, citing c. 245 of the Code of Ordinances, addressed the Committee during public comment and urged action to stop criminalizing and harassing unhoused people asking for money or panhandling on the street without a permit. On December 15, 2020, Solicitor Seewald informed the Committee that c. 245 dealt with commercial solicitation, not panhandling, that the Supreme Judicial Court had that day struck down the state anti-panhandling statute as a violation of the First Amendment, and that the City has no anti-panhandling ordinances. On that basis, on March 1, 2021, the Committee voted unanimously not to recommend the adoption of such an ordinance.

7. FIT Test and Capping of Size of New Single-Family Residences.

In a February 7, 2021 email, Jackie Ballance attached a document entitled “Equity in Housing” in which she urged the Committee to recommend use of a “‘FIT’ review for Equity, Environmental Sustainability, Appearance and Economy for every new residential building permit application.” That proposal would require a board to review

applications for fitness, including consideration of an applicant’s track record in creating fit housing. In a February 21, 2021 email, Ms. Ballance withdrew the fitness proposal and advanced a proposal to cap the size of new single-family residences at 1,100 square feet, with any larger proposed single-family residences required to “ask for an exception and expect a fair hearing.” The Committee thanks and commends Ms. Ballance for her thoughtful proposals and her commitment to the important issue of fairness and equity in housing in our City. However, Solicitor Seewald informed the Committee that state law prohibits zoning that regulates the interior size of a single-family residence. For that reason, on March 23, 2021, the Committee voted not to recommend Ms. Ballance’s proposals.

EXHIBIT B - "HOUSEKEEPING" CHANGES

GENERAL AND ZONING ORDINANCE CLEAN-UP - OFFICE OF PLANNING AND SUSTAINABILITY REQUESTED CHANGES						
#	Chapter	Section/Subsection	Link	Text to be Changed	New Text	Explanation
1	Ch. 337 Wetlands Protection	§337-2 Jurisdiction. G. Vernal Pool	https://www.ecode360.com/11956984	Nonresidential uses only in the Business Park District	Remove	BP Zoning no longer exists
2	Ch. 337 Wetlands Protection	§337-2 Jurisdiction. G. Vernal Pool Resource Area	https://www.ecode360.com/11956984	Central Business, General Business, Neighborhood Business, Highway Business, General Industrial, Special Industrial, Planned Village, Medical, Urban Residential-B and Urban Residential-C and municipal landfill properties	ADD Entranceway Business, Office Industrial	Reflect addition of newer zoning districts
3	Ch. 337 Wetlands Protection	§337-2 Jurisdiction. G. Vernal Pool Resource Area	https://www.ecode360.com/11956984	All areas in the Water Supply Protection overlay which were zoned residential as of January 1, 2006	Replace 'Overlay' with 'Zone'	Reflect shift in zoning from an overlay to an underlying zone
4	Ch. 337 Wetlands Protection	§337-2 Jurisdiction. G. Vernal Pool Resource Area	https://www.ecode360.com/11956984	All other areas not shown above (residential uses in the Rural Residential, Suburban Residential, Special Conservancy, Urban Residential A)	ADD Farms Forests and Rivers	Reflect addition of newer zoning districts
5	Ch. 337 Wetlands Protection	§337-10 Performance standards. B.	https://www.ecode360.com/11957049	Central Business, General Business, Highway Business, Neighborhood Business, General Industrial, Special Industrial, Planned Village, Medical, Urban Residential-B and Urban Residential-C Zoning Districts, within those portions of the Water Supply Protection Overlay District which was zoned industrial as of January 1, 2006,	ADD Entranceway Business, Office Industrial Replace 'Overlay District' with 'Zone'	Reflect addition of newer zoning districts, Reflect shift in zoning from an overlay to an underlying zone
6	Ch. 337 Wetlands Protection	§337-10 Performance standards. C.	https://www.ecode360.com/11957050	Entirety of Section C	Delete [Note: Requires renumbering of subsections D - G]	BP Zoning no longer exists
7	Ch. 337 Wetlands Protection	§337-10 Performance standards. E[7]	https://www.ecode360.com/14928507	Central Business, General Business, Neighborhood Business, General Industrial, Special Industrial, Planned Village, Medical	ADD Entranceway Business, Office Industrial	Reflect addition of newer zoning districts

EXHIBIT B - "HOUSEKEEPING" CHANGES

#	Chapter	Section/Subsection	Link	Text to be Changed	New Text	Explanation
8	Ch. 337 Wetlands Protection	§337-10 Performance standards. E[7]	https://www.ecode360.com/14928507	All water supply protection overlay areas zoned residential as of January 1, 2006, regardless of the underlying zoning, and all other areas	Delete <i>All water supply protection overlay areas zoned residential as of January 1, 2006, regardless of the underlying zoning, and</i>	Will read 'All other areas'
9	Ch. 40 Enforcement	§40-5 List of enforcing officers and penalties for noncriminal disposition. B.	https://www.ecode360.com/11953687	All instances of "Director of Planning and Development or his/her designee"	Change 'Development' to 'Sustainability'	Correct Department Title
10	Ch. 40 Enforcement	§40-5 List of enforcing officers and penalties for noncriminal disposition. B.	https://www.ecode360.com/11953687	Chairman, Conservation Commission	Change to 'Chairman, Conservation Commission or his/her staff agent or designee'	In practice, staff, rather than volunteer board members, issues violations for
11	Ch.156 Central Business and West Street Architecture	§156-10 West Street Architecture Process. B.	https://www.ecode360.com/14927884	Office of Planning and Development	Change 'Development' to 'Sustainability'	Correct Department Title
12	Ch. 161 Demolition	§161-6 Administration. B.	https://www.ecode360.com/11954485	Office of Planning and Development	Change 'Development' to 'Sustainability'	Correct Department Title

EXHIBIT B - "HOUSEKEEPING" CHANGES

#	Chapter	Section/Subsection	Link	Text to be Changed	New Text	Explanation
13	Ch. 161 Demolition	§161-6 Administration. D.	https://www.ecode360.com/11954487	The Commission shall create an inventory of significant buildings and structures built during the period of 1901 to 1939 that will be subject to this chapter within a two-year period from the date of the ordinance adoption. The Commission may also proactively develop other lists of significant buildings or structures that may be subject to this chapter. Buildings or structures proposed for the significant list of buildings and/or structures shall be added only following a public hearing.	The Commission shall create an inventory of significant buildings and structures built during the period of 1901 to 1939 that will be subject to this chapter within a two-year period from the date of the ordinance adoption. The Commission may also proactively develop other lists of significant buildings or structures that may be subject to this chapter. Buildings or structures proposed for the significant list of buildings and/or structures shall be added only following a public hearing.	Superseded by Ordinance Change that shifted applicable date to 1945
14	Ch. 161 Demolition	§161-8 Enforcement and penalties. A. Authorized agents	https://www.ecode360.com/11954492	Director of Planning and Development	Change 'Development' to 'Sustainability'	Correct Department Title
15	Ch. 350 Zoning	§350-3.4, 350-3.5, 350-7.4, 350-8.10, 350-8.8, 350-10.1, 350-10.4, 350-10.9, 350-10.15, 350-11.5		Planning and Development	Planning and Sustainability	Correct Department Title in various locations

EXHIBIT B - "HOUSEKEEPING" CHANGES

A

#	Chapter	Section/Subsection	Link	Text to be Changed	New Text	Explanation
ZIMNOCH REQUESTED CHANGES						
16	Ch. 312 Vehicles and Traffic	§312-99 Violations and penalties. B. (2) Group B. Fine \$15. #14	https://ecode360.com/11956780	Less than 15 feet of clearance	Less than 12 feet of clearance	Change for consistency with §312-27F. Section 312.27F is also recommended for further study. See Exhibit C.
Miscellaneous Changes Already Discussed						
17	Ch. 350 Zoning	§350-8.1 Off-Street Parking Requirements C. Table of Off-Street Parking Regulations	https://ecode360.com/11957545	Use. Any dwelling unit (including residential component of mixed residential/work space), except as noted below All districts other than CB (one space per) 500 square feet of gross floor area, up to a maximum of two per dwelling unit	All districts other than CB (one space per) 500 square feet of gross floor area, up to a maximum of two per dwelling unit. See specific district use table	Refer user to Table of Use and Dimensional Regulations for parking requirement. Present value is inconsistent with §350 Attachment 8 Table of Use and Dimensional Regulations, URC District, which lists parking requirement for dwelling units as one space per 1,000 sq. ft. gross living area.
18	Ch. 116 Alarms	§116-1 Responsibility for fines; violations and penalties	https://ecode360.com/11954076	§116.1 If any residence or place of business has an intrusion alarm which results in a notification to the Northampton Police Department of an alarm at said residence or place of business, the owner of the property or the tenant in possession, whomever has control of said alarm, shall be subject to a fine as set forth in Chapter 40, Enforcement, for each false alarm after the first three false alarms in any calendar year.	§116.1 If any residence or place of business has an an false intrusion alarm which results in a notification to the Northampton Police Department of an alarm at said residence or place of business, the owner of the property or the tenant in possession, whomever has control of said alarm, shall be subject to a fine as set forth in Chapter 40, Enforcement.	Phrase 'after the first three false alarms in any calendar year' conflicts with §40-5. [Per §40-5, 1st false alarm - no charge; 2nd false alarm - \$25; 3rd false alarm - \$50; 4th and subsequent - \$100] Insertion of the word 'false' is necessary because otherwise the ordinance renders anyone having an intrusion alarm (even if not false) liable for penalties.
19	Ch. 285 Streets, Sidewalks and Public Property	§285-32, §285-33, §285-34, §285-41, §285-43, §285-45,		Public Works Commission	Delete all references	No longer exists

EXHIBIT B - "HOUSEKEEPING" CHANGES

#	Chapter	Section/Subsection	Link	Text to be Changed	New Text	Explanation
20	Ch. 312 Vehicles and Traffic	§312-43 Parking for Physically Handicapped	https://ecode360.com/11956590	SEE ATTACHMENT	Change references to 'handicapped,' 'disabled' and 'disability' to accessible parking language.	Revised to update language as attached. The Northampton Disability Commission has reviewed and approved these proposed amendments.

Report of the 2020 Special Committee for Review of Ordinances

Exhibit C

Ordinances Recommended for Further Study

1. Charter Review.

Member Paik suggested that the Committee recommend that the review of the Northampton City Charter pursuant to Section 10-6 of the Charter and Chapter 9 of the Code of Ordinances, which is undertaken at ten-year intervals in years ending in a nine, be increased in frequency. Member Paik noted that, as part of ordinance review, committee members discovered that many areas of concern are in the exclusive purview of the executive branch. The Mayor has broad powers to be able to create departments, set policy, hire staff, etc. On March 23, 2021, the Committee voted to recommend further study of this issue.

2. Rental Agency Fees.

The Committee considered a proposed ordinance that would prohibit charging tenants a rental agency fee and require that any such fee be paid by the landlord. While the Committee believed that such an ordinance would alleviate the cost burden to renters, City Solicitor Alan Seewald advised the Committee that such legislation would violate the provision of the Home Rule Amendment to the Massachusetts Constitution that prohibits local legislation that alters civil relationships. According to Solicitor Seewald, the contract between the landlord and the rental agency, which requires that fees be paid by the prospective tenant, is such a civil relationship. Such an ordinance could be adopted only after a special act is passed by the state legislature and signed by the Governor. On that basis, on March 1, 2021, the Committee voted unanimously not to recommend the adoption of such an ordinance but, instead, to urge the City Council to study this issue and to file a petition for special legislation with the state legislature to authorize such an ordinance.

3. Towing of Vehicles Impeding Snow Removal Operations.

Councilor Foster brought to the Committee's attention § 312-51, The Towing of Vehicles Impeding Snow Removal Operations, which creates significant financial and logistical hardship for lower income residents who are primarily renters without dedicated parking spaces. The Committee referred the issue to Planning Board for review and comment. The Planning Board pointed out that the parking issues cited by the councilors appear to arise around pre-existing, non-conforming properties that are not required to comply with the parking requirements in our zoning and recommended:

- Improve seasonal messaging around snow emergencies, parking restrictions, and clearing snow from sidewalks;
- Explore a reduced or free towing fee/fine for first time offense;
- Provide more consistent parking enforcement across the city;

- Develop a renters' folder with important information;
- Explore pop-up parking lots on private property; and
- Inquire with the NPD where such towing occurs and better communicate with the residents in that particular area.

Councilor Nash informed the Committee that he and Councilor Foster will continue to study this issue. On March 23, 2021, the Committee voted to recommend further study of this issue.

4. General Sign Regulations.

Councilor Alex Jarrett asked the Committee to recommend that the City Council review §350-7.2 General Sign Regulations based on the Supreme Court decision Reid vs. Town of Gilbert. That case significantly changed the permissible scope of regulation of signs by prohibiting differentiation of regulation based upon the content of the sign. City Solicitor Seewald explained that the existing ordinance is not being enforced and that he has taken up this issue with the Council President and the Assistant Director of Planning and Sustainability. The Committee voted on March 15, 2021 to urge the City Council to continue to study this issue and to revise the existing ordinance to conform to Supreme Court precedent.

5. Proposal to Expand Notification under §350-3.5.

Councilor Nash proposed an ordinance to expand notification of proposed changes to zoning district lines under §350-3.5 to include owners and tenants of abutting properties in addition to owners of affected properties. The Committee referred the issue to the Planning Board for review and comment. While the expansion of notification would provide greater transparency regarding nearby zone changes, the Planning Board had concerns with the ability of the city to identify those entitled to expanded notice and the potential that such an ordinance would increase litigation against the city. The Board recommended:

- Develop an address list of property owners and residents for mail notification;
- Develop an address list where notices are sent to the "resident" at a given address, forgoing the need for a resident's name; and
- Increase use of listservs for notification (Planning Department, City Councilors, neighborhood groups, etc.).

Councilor Nash informed the Committee that he and Council President Sciarra will continue to study this issue. On March 23, 2021, the Committee voted to recommend further study of this issue.

6. Commercial Buffer Zone Proposal.

Councilor Alex Jarrett suggested that the Committee recommend a Commercial Buffer Zone Proposal to supplement § 312-25 Prohibited Activities During Certain Hours of the

Day with specific regard to commercial trash removal in proximity to residential structures. The ordinance is general in nature, but it uses zoning terminology in terms of location of its applicability. The Committee noted that there would be difficulty in determining exactly where that line of demarcation would be located. Action was deferred at Councilor Nash's request pending further research. On March 23, 2021, the Committee voted to recommend further study of this issue.

7. Unobstructed Lane of Travel.

Fred Zimnoch brought to the Committee an inconsistency between §312-27(F), which prohibits parking that would not leave a 12' wide unobstructed lane for passing traffic, and the enforcement provision contained in §312-99. In Exhibit B to this Report, the Committee has recommended that the two provisions be made consistent at a width of 12 feet. At the same time, the Director of the Department of Public Works pointed out that literal enforcement of this provision would require that parking be prohibited on many older streets in the more densely populated areas of the City, where the road width would not permit such an unobstructed lane along parked cars. Considering the balance necessary between the need for parking in those neighborhoods and the need for safe passing lanes, on March 23, 2021, the Committee recommended further study of this issue.



Roll Call

CITY COUNCIL MEETING
 CONDUCTED AS AN ON-LINE ZOOM MEETING
 Northampton, MA

A regular meeting of the City Council was called to order by Council President Gina-Louise Sciarra. At 7:31 p.m. on a roll call the following City Councilors were present:

- | | |
|--|--------------------------------------|
| At-Large Councilor Gina-Louise Sciarra | At-Large Councilor William H. Dwight |
| Ward 1 Councilor Michael J. Quinlan, Jr. | Ward 5 Councilor Alex Jarrett |
| Ward 2 Councilor Karen Foster LaBarge | Ward 6 Councilor Marianne |
| Ward 3 Councilor James B. Nash | Ward 7 Councilor Rachel Maiore |
| Ward 4 Councilor John Thorpe | |

Announcement of Audio/Video Recording

Councilor Sciarra announced that the meeting was being held by remote participation and audio and video recorded.

Public Hearings Announcement of public hearing concerning the Northampton Capital Improvement Program for FY2022-FY2026 - Thursday, March 18, 2021

Public Hearings Announcement of a public hearing concerning the Northampton Capital Improvement Program for FY2022-FY2026 - Thursday, March 18, 2021
 Councilor Sciarra made the following announcement:
 In accordance with Article 7, Section 7-5 of the Charter, the Northampton City Council will hold a public hearing via remote participation on Thursday, March 18, 2021 at 7:05 p.m. The City Council will consider the Capital Improvement Program for FY2022-FY2026, and hear all persons who wish to be heard thereon. Instructions for accessing the hearing will be posted on the March 18, 2021 City Council agenda to be posted no later than 48 hours prior to the meeting on the city website at www.northamptonma.gov. The CIP is available for inspection [here](#).

Announcement of public hearing to consider FY 2022 Water and Sewer Rates

Announcement of a public hearing to consider FY 2022 Water and Sewer Rates
 Councilor Sciarra announced the following:
 The Northampton City Council will hold a public hearing by remote participation on Thursday, March 18, 2021 @ 7:15 p.m. The City Council will consider the proposed FY2022 water and sewer rates and hear all persons who wish to be heard thereon. Instructions for accessing the hearing may be found on the March 18, 2021 City Council agenda to be posted on the city website, www.northamptonma.gov, no later than 48 hours prior to the meeting.

I Updates from Council President/ Committee Chairs

Updates from Council President and Committee Chairs
 None.

Recognitions and One-Minute Announcements by Councilors

Recognitions and One-Minute Announcements by Councilors
 The Northampton Policing Review Commission (NPRC) is holding its third and final public hearing Saturday, March 6, 2021 at 11 a.m. The outreach form is readily accessible now from the NPRC’s page on the city website.

 The Planning Board and City Council Committee on Legislative Matters will hold a joint hearing this Monday, March 8, 2021 to take up ordinances related to affordable housing and half-scale housing units at 7 p.m.

And, a public forum on river swimming covering the Mill River and a myriad of issues around swimming holes is March 10, 2021 at 6 p.m., Councilor Maiore reminded. She will post a link to a survey asking basic questions about the use of the Mill and Connecticut Rivers for swimming and related issues on social media.

Communications and Proclamations from the Mayor

Communications and Proclamations from the Mayor

Mayor Narkewicz gave a brief update on vaccination clinics. At the last meeting, he noted Northampton was in the process of applying to become a regional vaccination site and mentioned some of the challenges with the scheduling system and vaccination supply. He would like to be able to report that things have improved radically, but unfortunately they have not. Councilors may have been hearing from constituents about the cancellation of appointments, and he knows this has caused a great deal of concern, frustration and anxiety. As he has reiterated, the 60 people who run those clinics share that frustration. He continues to stress to people that the scheduling system itself is a state system. They understand it has quirks and incredible wait times; most importantly, it is something they don't have control over. The vaccination supply system has driven the recent cancellations.

The problem has been especially pronounced with Moderna vaccines where they have had a shortage and lots of people waiting for second vaccines, he elaborated. Local administrators continue to press the state for additional vaccine supply. The folks who have accessed and used the senior center have been to a person incredibly impressed and grateful. They have been able to move hundreds of people through the building. In order to accommodate the additional traffic, they have literally had to deconstruct the fitness center and put it into storage. People register and then are separated into pods throughout the building. They have done everything they can [to insure smooth operation]. When the goal posts got moved and they were told they had to shut down, they did everything they could to ramp up, but, sadly, they have been receiving fewer vaccines than before they became a regional vaccination center. They are extremely excited and heartened that both President Biden and now Governor Baker have said educators should be prioritized, and the governor has announced he is now moving toward that goal. The challenge is that none of the other things mentioned have changed, once again putting incredible pressure on local Boards of Health. He wanted to give people a sense of that because he understands how anxiety-producing it is, but it is outside of the city's control.

Supply and logistics continue to be a major concern. They know people want to call the senior center and health department and realize they can't answer all of those calls immediately. Clinic coordinators are doing incredible work with a variety of medical corps, EMT's, volunteers, etc.

Councilor Sciarra thanked the mayor for the remarkable effort to get Northampton to become a regional site.

Resolutions 21.201 Resolution in Opposition to State Incentives for Biomass Plants -1st reading

Resolutions

21.201 A Resolution in Opposition to State Incentives for Biomass Plants - 1st reading

Councilor Dwight moved to approve the resolution in first reading. Councilor LaBarge seconded.

Councilor Sciarra read the resolution.

Councilor Jarrett thanked Adele Franks, Climate Action Now and co-sponsors Councilor Maiore and the Northampton Energy and Sustainability Commission (NESC). He thinks this speaks to the need to be very careful about what they consider renewable. There are existing small, efficient combined heat and power biomass plants that use waste wood chips such as the one at Cooley

Dickinson Hospital that supplies electricity, heat and hot water effectively. What they're primarily opposing here is not that, but inefficient power facilities that would require much more biomass than the waste available. These incentives are paid for by taxpayers and ratepayers and the result is pollution in many forms that imperils them and their Springfield neighbors in the short-term and creates CO2 emissions that endanger the future. There are two bills in the state legislature that they decided not to mention (Senate Bill 2381 and House Bill 3753) because they did not have consensus around some of their provisions but he encouraged listeners to look them up.

Councilor Maiore reiterated that Springfield has one of the highest rates of asthma in the country and is a vulnerable community with fewer resources to fight something this large and that Northampton is not physically far enough to escape its impact. She mentioned state legislators that have shown opposition and the Springfield City Council. The thing that strikes her is the perversity of getting ratepayers to subsidize their own ill health. They are spending \$175 million dollars over 20 years to subsidize particulate pollution in their own air. This really strikes her as quite wrong.

Councilor Dwight said he is grateful to the proponents and sponsors of this resolution. The cruel irony is that 10 or 11 years ago they were resisting the same project. At the time, he was working on a radio show and heard from proponents and opponents. Proponents actually benefitted from the ability to have an unabashed cynical attitude to this. It is cynical to allude to this as a renewable energy; it is not in any way, shape or form. It ostensibly uses and burns a carbon sequestration system - wood - and at the same time reintroduces carbon back into the atmosphere, the whole thing they're trying to arrest. The same sense of urgency existed then and here they are now having the governor and his agents making an expedient decision to allow just this one biomass plant. It looks like a 'gimme' to somebody.

The most grotesque part and something seen system-wide with every kind of energy-generation facility, is that plants are located in areas that do not have the means or the agency to defend themselves. This is seen with landfills being located proximate to communities that cannot protect themselves. Springfield has suffered a number of insults when these types of cynical projects are established. Holyoke took down its coal plant. They actually wrote a resolution in opposition to that as well. They now have the opportunity to join forces regionally to say they will not abide by this perversion of the concept of green and renewable energy. "We are joining forces, we will circle the wagons with them if we vote in favor of this," he noted. He is very grateful to sponsors for giving them this opportunity, he concluded.

Councilor Foster thanked cosponsors and proponents. She was struck by Councilor Maiore's comment that ratepayers would subsidize their own ill health. She thinks it is also important to put the additional face on it of the individuals who would subsidize this. "We as taxpayers would be asked to subsidize this financially," she observed.

Her younger child has asthma and for about a year and a half it was not well-controlled, she related. She remembers constantly looking at the emotional and financial cost of dealing with an individual in the family with asthma - it is significant. They might need to listen to her talk for about five hours to know the incredible burden asthma can bring to a family when it is not well-controlled. They have made ER trips, they have missed so much work, he has missed so much daycare and all of these costs are costs shouldered by individuals. She mentioned co-payments, nebulizer, prescriptions, medication monitoring, etc. Those are costs that are hard to quantify to a family. His episodes would last for several days. She remembered one night watching him sleep and checking his respirations and feeling anger knowing that individuals and families were bearing the cost - especially individuals whose asthma is triggered by air quality - of things like a biomass plant and air pollution. It's out there in the ether.

She wholeheartedly supports the resolution and definitely stands in solidarity with Springfield and the Springfield City Council in resisting this coming to their community.

Between people who spoke in public comment and his colleagues tonight there is no way he could express thoughts better than what has been heard, Councilor Quinlan stated. He wondered if in the final 'Therefore Be It Resolved' clause it would be possible to list the Springfield City Council as a recipient and send them a copy.

He so moved. Councilor LaBarge seconded. The motion to amend passed unanimously 9:0 by roll call vote.

Councilor LaBarge said she has relatives in Springfield and Holyoke who are very upset about this coming forth in Springfield. Way back they bought a wood stove from a Hadley shop. They had wood delivered and started burning and within two weeks she started itching. She ended up seeing Dr. Gilburn, an allergist, and finding out she was allergic to every tree except for pine. She agrees with the resolution. It almost reminds her of the landfill on Glendale Road, fighting and fighting for people who were becoming so ill.

"I do not support that happening in Springfield," she said. It is not just going to affect Springfield, it will be Holyoke and them also. She wants to make sure everybody here in Northampton and Springfield are not affected. "There's a lot of health issues that can occur with this."

Councilor Nash thanked sponsors and speakers. The education that's gone along with all the testimony tonight has been very profound and is really appreciated.

Councilor Sciarra said she thinks it is very important to stand in solidarity and to fight for their neighbors. Of course, it was stated that this is also in their own best interest and in the interest of the world.

The motion passed unanimously 9:0 by roll call vote.

See minutes of May 18, 2021 for second reading.

Package of Zoning Amendments to Allow Two-Families by Right in All Residential Zoning Districts - 1st reading

Package of Zoning Amendments to Allow Two-Families by Right in All Residential Zoning Districts - 1st reading

Councilor Sciarra stated her intention to take the package of zoning ordinances out of order since there were audience members present for this item.

Hearing no objection, she moved to item #17 on the agenda. She recited the history of council action on the ordinance to date and read the proposed new definitions. The ordinances are a challenging group to read in a way that elucidates rather than makes them confusing, she noted. Her suggestion is to put them on the floor as a group and put them up on the screen.

Councilor Dwight moved to approve the ordinances as a group in first reading. Councilor Jarrett seconded.

Councilor Sciarra read the definitions, and Office of Planning and Sustainability (OPS) Assistant Director Carolyn Misch gave a Powerpoint presentation.

The ordinances have been through a public hearing process and they have talked on a few occasions about the context of the two-family by right proposal, Ms. Misch reminded. It is part of an overall series of amendments the mayor and planning office are sponsoring to try to address the issue of housing in Northampton, close the gap in needs that have been identified through several studies and planning processes and provide opportunity for housing options at

all income levels. For further context, Councilor Jarrett announced a public hearing on March 8th with the Planning Board on ordinances to create incentives for affordable housing and for half-scale units. In addition, planners are working on zoning amendments that would allow the ability to create ground-floor, multi-family housing in downtown Florence and downtown Northampton to create opportunity for higher density housing in those districts.

The reason for focusing on two-families is to address equity by providing more rentals in all neighborhoods of the city - not just areas where two-families are currently allowed - provide opportunities for individuals to access housing at a lower median price and concentrate development in areas where infrastructure already exists to reduce the city's carbon footprint, Ms. Misch explained. Transportation and housing are the biggest areas with opportunities for reducing the city's carbon footprint. They are working simultaneously to match up housing and transportation needs and to reduce the demand for travel.

The proposal is a way to create housing opportunities that meet a greater percentage of the needs identified for residents and people trying to buy into the Northampton market or find rental housing, she continued. Two-family homes are smaller and therefore less costly for people entering the market. They have looked at median house sizes for single-family homes vs. two families. The median size for single-family homes is 1,779 s.f. while the median unit size for two-families is 1,200 s.f. Two-families require less impervious surface per person and consume less energy, particularly in situations where there are shared party walls.

Ms. Misch showed a map of the areas where two-families are currently allowed by right, Urban Residential B (URB) and Urban Residential C (URC). They are the two districts surrounding downtown, covering the area of densest housing stock in Northampton. What this ordinance will do is open it up to allow two-families essentially in all other [residential] areas of the city.

As part of the package, they are restructuring definitions and essentially eliminating the definition of accessory dwelling unit (ADU), Ms. Misch continued. They now allow ADU's throughout the city but they are capped at 900 s.f. and the owner is required to live in the unit. They are taking that element away and just calling it a two-family. Two units would be allowed in any context without the cap and without the ownership requirement. They are also creating a series of design standards for two-families that they haven't had to date which require modifications of the Tables of Use of some zoning districts.

The package was introduced as ten ordinances, but there is a recommendation to eliminate one of them (20.169). Part of this is also reformatting the Water Supply Protection (WSP) district table to match the formatting of other tables. There is also an element that would require the addition of two units to include a fossil fuel-free heating system. And, there is a clean-up of items, including eliminating any reference to the residential incentive overlay district.

A joint public hearing was held January 14th. The hearing was closed, but there was a continuation of discussion until February 8th. In the intervening time, modifications to some of the ordinances were introduced based on questions and concerns raised during the public hearing.

Ms. Misch reviewed the amendments to the ordinances since they were originally introduced in response to the comments heard.

On February 8th, the two bodies reconvened and took votes on the ordinances as amended. The Planning Board voted 5 to 2 to recommend approval with the modifications. Of the two members who voted not to recommend the package - Christa Grenat and Alan Verson - one member was concerned about the fossil fuel-free component and would otherwise have voted on the package if that

could have been extracted. She wasn't against the entire package, just the component related to the requirement for the heating system to be fossil fuel-free.

The other member didn't like the fossil-free component but also was concerned that there wasn't a cap on the size of the two-family units and so voted down the entire package based on size. At the time, it was not clear that there was a whole series of amendments coming in steps. One of the other proposals provides an incentive for creating smaller units which they feel complements the two-family proposal, so it is their belief it does not limit the ability to create smaller units.

Ms. Misch offered to entertain questions or go into more detail.

DISCUSSION

She had a conversation earlier this afternoon with Councilor Jarrett about the screening requirement in the design component of the package (20.166), Ms. Misch added. He raised a concern about an owner not having the opportunity to replace trees on a property to the extent required. He mentioned interest in discussing waivers for people who might not have space on a particular lot to both add a second unit and plant additional trees to offset the trees being cut. She said she'd be happy to discuss that further.

Councilor Nash expressed his understanding that the Sustainable Northampton Plan presents the concept that infill is supposed to happen in the urban core and that outer areas are to be protected to preserve wildlife habitat and the watershed. In terms of that perspective, [development] is about 'hitting the bullseye on the target of Northampton,' particularly the urban and village centers. This seems to be going counter to that, he observed.

Ms. Misch emphasized that planners have allowed ADU's as part of single-family homes in all parts of the city but it comes with a restriction on the size of the unit so it limits flexibility for people with different family needs. This allows more flexibility and provides rental opportunities in areas of the city where they are not currently allowed. It is sort of the half-step to allowing more residential. They are not increasing density by leaps and bounds in more suburban areas but are providing options for people who might want to live or rent in areas that are not in the core. Single-family home zoning is exclusive and sort of demarcates who's allowed and not allowed. They want to start to lift those historic patterns of inequity and acknowledge the fact that they don't want to create barriers for people in their choice of where they want to live.

Councilor Nash said he gets that but thinks they need to acknowledge that they are pushing into one of the goals of the plan, namely, to preserve habitat and the watershed.

None of the other regulatory structures are being reduced or eliminated in this process, Ms. Misch pointed out. They still have the local wetlands ordinance and the Wetlands Protection Act (WPA). What they're talking about probably is one additional unit or an expansion of an existing accessory unit in a single-family home in a building envelope that already exists. By that they are actually reducing the pressure on building further out or shifting people into Easthampton or Greenfield. By allowing more households on a property where zoning would only allow a single-family home they are reducing the impervious surface and built area needed to accommodate two households. It meets the goals of both the sustainable Northampton and the updated Climate Resilience and Regeneration Plan, she confirmed.

Councilor Nash said he appreciated the case made for two-families and thinks the two-family model is more efficient, more economic and adds flexibility in all of the zones throughout the city. The thing he's wondering about is the jump to allow an additional structure of unlimited size on a property. Right now they're joined together - two families and two single-family homes on a lot. He asked

how planners thought combining them was the way to go. He sees them as almost two different things to be considered.

Zoning currently allows detached accessory dwellings in all areas of the city by special permit, Ms. Misch responded. Ultimately, it is still two units per parcel. There are still open space constraints on a property so the maximum allowed impervious surface is not proposed to be changed. Whether someone puts a detached garage that is 1,200 s.f. on a property or a detached 2nd unit, they are going to look at those the same. As long as an applicant is meeting open space requirements and setbacks, they could have either a detached garage or a detached second unit.

Councilor Nash asked if there is a way to incentivize two-families in this. Part of the incentive is that it is more economical than building a whole new structure with a whole new system. He asked if she thinks that's enough incentive to promote two families over two separate houses on a lot. In terms of sustainability and affordability, he would like to see more two-families across the city than two separate houses on a lot.

To some extent that's trying to predict the market, Ms. Misch responded. "I don't have a crystal ball; I don't know," she said.

It seems like the two-family is incentivized just by the nature of it, Councilor Nash commented.

Regarding the fossil fuel restriction, Councilor Dwight noted this came up during the joint hearing and in public comment by former Councilor David Murphy. He pursued this with Adin Maynard, former chair of NESAC and also an energy consultant. He also spoke to someone who builds small accessory units about the feasibility of creating a house that can be sustained without fossil fuel. They both said it is eminently doable especially when conforming to the stretch code.

Mr. Murphy referred to the fact that in Brookline it was rejected out of hand with the explanation that its appropriate place is in the building code.

CITY SOLICITOR OPINION ON FOSSIL FUEL-FREE RESTRICTION

The Brookline provision was reviewed and rejected by the state Attorney General (AG); it was not a court decision, Attorney Seewald clarified. Town bylaws become effective only after review and approval by the AG. Cities are not bound by that review so the review is not binding on them. It had to do with a much more elaborate scheme to regulate the use of fossil fuels. The bylaw applied to all major commercial structures, set up a review board and was much more elaborate than what they're doing here. The AG reply focused more on the supply and alternatives than what they're doing here, which is incentivizing smaller two-families. On a larger two-family, developers are going to have to go to non-fossil-fuel heating systems.

It is a close call, he acknowledged. The AG recognized that sustainability is a proper focus for zoning but struck down the way Brookline did it.

Here, Northampton does not have to allow two-families at all. It is his position and something that's never been ruled on by a court that they have the right to determine the terms upon which they will allow two-families as of right over 2,000 s.f. in size. There is no state policy on the conditions upon which all cities and towns must allow two-family residences. They are allowing something that they're not necessarily required to allow and are conditioning it on a certain form of energy to heat it. He's not here to comment on the wisdom of any of this but is here to say that the focus is not on the state policy of how energy is delivered or how systems are constructed and installed, the focus here is whether to allow two families in all districts or not.

Councilor Dwight said it seems to him that by making this fossil fuel-free

restriction they also incentivize smaller structures. As to the efficacy of air source heating pumps, with a smaller envelope it is much easier to manage, control and maintain the supporting heating system. They heard Mr. Murphy refer to the potential of people freezing to death because there is no redundancy in it. He noted there's not a lot of redundancy in homes with fossil-fuel heating systems either.

The loaded question is whether they think this incentive actually threatens the viability and prospect of more two-family homes being developed, Councilor Dwight stated.

Attorney Seewald said he also has no crystal ball. All he can say is that the ordinance as developed at this moment would allow any builder to build with fossil fuels under 2,000 s.f. To that extent, it incentivizes the construction of smaller units. He knows there are those in the city who would very much like to see smaller units that are more affordable.

They are already seeing a lot of new construction with air source heat pumps, Ms. Misch said. When building new construction to the stretch code, the fact that the structures are much tighter means they don't require as much energy to heat. Even if they had a back-up heating system, it's not going to take a lot to heat that space. The building envelope is very tight because of the stretch code requirements for insulation.

Outside of URB and URC, any two-family is going to trigger site plan review, she added.

All heating systems now have an electrical panel, so it doesn't matter if households don't have electric heat, they still won't be able to turn their heating systems on, Ms. Misch continued. "All of us are going to have problems no matter what kind of heat source," she pointed out. Based on the fact that there are builders now who are including these systems she doesn't think it is necessarily going to restrict the development of new two-families.

Without expressly saying it, what they're proposing is actually a built-in incentive not to go Mc-Mansion but to be more restrained in whatever system is chosen, Councilor Dwight suggested.

Ms. Misch allowed that was a valid theory. If builders go smaller to avoid site plan review, they could put a gas furnace in, but at that point it is such a small unit anyway that it might not make sense. There are probably a lot of ways to look at it, she noted.

Councilor Dwight said it is worth noting there is still a standing moratorium on gas development.

There's always propane and oil, Ms. Misch reminded.

Councilor Jarrett said he's also done some research. He spoke with Adin Maynard and folks at Northeast Energy Efficiency Partnerships (NEEP). He thinks the consensus is that, for a smaller unit, the installation cost of a heat pump system is less than a fossil fuel-based system. Whole house heat pumps are also getting significant rebates from the Mass. Clean Energy Center. The only place that the technology is not mature enough is for very large buildings. He has spoken to people and feels very comfortable moving forward in first reading.

For the next 20 minutes, members asked questions and offered comments and Ms. Misch shared further details of specific components of the two-family proposal and related zoning provisions. Topics discussed included the zero lot line provision, minimum lot size, the placement or 'fit' of new construction in relation to existing structures and the difference in fossil fuel-free requirements for the two-family proposal vs. the affordable housing and half-scale housing

proposals.

Councilor Dwight reminded fellow councilors that the two-family proposal is one leg of a four-legged table which, in toto, will create more affordable opportunities but also more opportunities for people in the middle and upper income range. Every time they propose and change zoning with the overall objective to increase opportunity and affordability, it is always met with resistance principally based on the way people fear it would change the character of their neighbor-hoods. The resistance is to not being able to control and manage the immediate environment.

This conversation has been very deliberative and thoughtful, and he is grateful for Ms. Misch and Director Feiden's patience on this. "I'm ready to move on these personally," he said.

Councilor Maiore said she wanted to honor the work residents have put in, especially Bay State residents. She sees their passion and their stress and concern. She doesn't think what they're concerned about can actually be solved in this package or ordinances. She just wants to say, "I hear them."

She knows Mr. Handzel is on the call and that there are potentially four to six more units to be built in that area. She is hoping Mr. Handzel has heard the comments and that Bay Staters have heard what they're doing here. She wondered if there are further things they can do for concerned residents around these changes.

Councilor Jarrett said he also feels the frustration about the limitations of what they're able to do with zoning. They can't regulate single-family homes and they can't regulate the issue of wealth and inequality. He thinks 5,700 s.f. single-family homes going in and replacing affordable housing is 'grotesque.'

"We don't have the ability to regulate this but we can provide incentives and I think that's what we're trying to do," he concluded.

20.166 Section 4 Screening

Councilor Jarrett raised concern about a homeowner not being able to meet the tree planting requirement of 20.166 Section 4 Screening above and beyond the requirements of the Significant Tree Ordinance. Section 4 requires that, for every tree over three inches (3") in caliper removed, a one-inch (1") replacement tree must be planted. What if a property owner had to remove 20 or 30 3" trees and couldn't fit all the 1" trees on the lot? He asked. He wanted to make sure there was some flexibility to allow people to proceed with a project if they weren't able to fit all the required trees on the property.

Ms. Misch said it is a good point. Often there are alternative ways to meet a standard or ways of waiving a standard. She has some language that could be added to the screening section to allow the Planning Board to waive the total number of trees to be planted if it finds it's not feasible to replace all the trees and at least one 1" tree is planted. She said she forwarded the language to the administrative assistant. She agreed having a relief valve makes sense.

Councilor Nash said his questions have been answered. He is interested in hearing from councilors whose wards are more strongly impacted about how they picture the changes might affect their residents. He voiced his intention to do some outreach to his constituents to make sure people are well aware of the proposal to allow a second home on a single lot before he votes on this measure in two weeks.

Councilor Jarrett clarified that it is only in outlying zones that the ability to add a second unit is changing. In URB and URC zones, a second detached dwelling is already allowed.

Councilor LaBarge thanked Ms. Misch, saying she thinks she has explained it

very, very thoroughly. She thinks the ordinance is an excellent ordinance for enabling people to have a home and live in Northampton at a price that is a very good price.

Ward 6 has areas of smaller homes and homes built a year and a half ago for \$2.5 million and one on Florence Road for \$1.9 million. "I'm so happy about this," she enthused. Ward 6 has affordable housing on Emerson Way and Burts Pit Road. She thinks it is a great asset to wards in the city.

Councilor Jarrett said he is also really happy about this ordinance. Regarding the suggestion made during the public hearing of having a limit on the size of second units and concern that they will see a lot of large, expensive homes, presently, owners can build a 2nd unit of any size in URB and URC zones and they're not seeing a lot of very large second units, he pointed out. He wants to keep thinking about it but he is just not sure limiting the size of the second unit would have the desired effect. He would love to hear if any other councilors have thoughts on this.

When running for City Council, one of the things she heard most was the need for more affordable housing, Councilor Foster shared. She is glad to see an ordinance making it easier for multi-family homes to be built. Most of her questions were answered through the hearings. To Councilor Jarrett's point about limiting size, families are looking for housing too, and it is hard to come by. She doesn't know what the benefit would be. Just as there are singles and couples looking, there are families with multiple children looking, too. Units that can accommodate a family with multiple children would be really valuable.

Councilor Sciarra agreed this is an important area of the market they need to grow.

Councilor Dwight mentioned that sponsors have asked to remove one ordinance, 20.169.

When initially introduced, there was a provision that would allow slightly larger two-families to go through without site plan approval which required an amendment to the site plan section (subsection 11) itself, Ms. Misch explained. Given that through public comment, they have eliminated the distinction of allowing slightly larger two-families to go through without site plan approval, it has been withdrawn.

Councilor Dwight amended his motion to remove ordinance 20.169 from the package to be approved in first reading. As the second to the original motion, Councilor Jarrett consented to this friendly amendment.

The motion to approve the ordinances in first reading with 20.169 removed passed unanimously 9:0 by roll call vote.

Ms. Krutzler clarified that council rules state that items may be removed upon the written request of the sponsor with no vote. The sponsor has made a written request for withdrawal of 20.169, so no vote to accept withdrawal is necessary, she confirmed.

See Minutes of March 18, 2021 for second reading.

**20.182
Ordinance
Relative to
Demolition
Review for
Historically-
Significant
Buildings - 1st**

20.182 An Ordinance Relative to Demolition Review for Historically-Significant Buildings - 1st reading

Councilor Sciarra read the ordinance.

Councilor Quinlan moved to approve the ordinance in first reading. Councilor LaBarge seconded.

Conservation, Preservation and Land Use Planner Sarah LaValley said the

<p><u>reading</u></p>	<p>proposed changes are pretty straight forward on their own although she knows a lot of semi-related changes came up in Legislative Matters. This is basically a clean-up. Committee appointment language belongs in the administrative code and references to the Office of Planning and Development are being changed to the Office of Planning and Sustainability. When the demolition ordinance first passed it only applied to buildings through 1900. Since then the City Council and Historical Commission have moved that date up to 1945, that piece is no longer relevant.</p> <p>The motion passed unanimously 9:0 by roll call vote.</p> <p><u>See minutes of March 18, 2021 for second reading.</u></p>
<p><u>RECESS</u></p>	<p><u>RECESS</u> The City Council recessed briefly at 9:47 p.m. The City Council reconvened at 9:55 p.m.</p>
<p><u>Consent Agenda</u></p>	<p><u>Consent Agenda</u> Councilor Sciarra reviewed the consent agenda, offering to remove any item for separate discussion upon request. Councilor Dwight moved to approve the consent agenda as presented. Councilor LaBarge seconded. The motion passed unanimously 9:0 by roll call vote. The following items were approved as part of the consent agenda: A. <u>Minutes of February 4, 2021 City Council Meeting</u> B. <u>21.206 Appointment of David Whitehill to the Planning Board - for referral to City Services</u> <u>Planning Board</u> David Whitehill (Full Member), 60 Washington Avenue, Northampton Term: March 2021-June 2022 <i>To fill the term of resigned full member, Alan Verson</i></p>
<p><u>Recess for Committee on Finance Meeting</u></p> <p><u>Financial Orders (on 1st reading pending Finance)</u> <u>21.202 An Order to Authorize Acceptance of Gifts of Labor and Materials for Sidewalk Repair or Replacement - 1st reading</u> <u>21.203 An Order to Discontinue a Portion of Sherman Avenue - 1st reading</u> <u>21.204 An</u></p>	<p>At 9:56 p.m., the City Council recessed for the Committee on Finance. The Committee on Finance adjourned at 10:47 p.m. The City Council reconvened at 10:47 p.m.</p> <p><u>Financial Orders (on 1st reading pending Finance review)</u> <u>21.202 An Order to Authorize Acceptance of Gifts of Labor and Materials for Sidewalk Repair or Replacement - 1st reading</u> Councilor Dwight moved to approve the order as amended in first reading. Councilor LaBarge seconded. The motion passed unanimously 9:0 by roll call vote. <u>See minutes of March 18, 2021 for second reading.</u></p> <p><u>21.203 An Order to Discontinue a Portion of Sherman Avenue - 1st reading</u> Councilor LaBarge moved to approve the order in first reading. Councilor Dwight seconded. The motion passed unanimously 9:0 by roll call vote. <u>See minutes of March 18, 2021 for second reading.</u></p> <p><u>21.204 An Order to Release a Parking Easement on Glendale Road - 1st reading</u> Councilor LaBarge moved to approve the order in first reading. Councilor Jarrett seconded. The motion passed unanimously 9:0 by roll call vote.</p> <p>Councilor LaBarge moved to suspend rules to allow a second reading.</p>

**Order to
Release a
Parking
Easement on
Glendale Road
- 1st reading**

Councilor Foster seconded. The motion passed unanimously 9:0 by roll call vote.

Councilor Dwight moved to approve the order in second reading. Councilor LaBarge seconded. The motion passed unanimously 9:0 by roll call vote.

The following order passed two readings:

City of Northampton

MASSACHUSETTS

In City Council, March 4, 2021

Upon the recommendation of Mayor David J. Narkewicz and Office of Planning & Sustainability

21.204 An Order to Release a Parking Easement on Glendale Road

WHEREAS, On March 1, 2001, City Council authorized the City to take by eminent domain land off Glendale and Westhampton Roads for a landfill buffer, open space and recreation, and housing and affordable housing, and authorized the Mayor to sell those housing building lots, including “Lot 6” and “Lot 7”; and

WHEREAS, As part of this transaction, the deed for the conservation area (recorded on June 23, 2003 at the Hampshire Registry of Deeds, Book 7271, Page 216) provides for a Parking Easement described as follows: “the Conservation Commission shall be allowed to build, without limitations, a three-car parking lot...provided such parking lot does not block reasonable access to Lot 6”; and

WHEREAS, The City has a buyer for Lot 6 and Lot 7 (previous lots from this limited development were donated to Habitat for Humanity and sold to a private party), who has proposed a driveway location consistent with future placement of a three-car parking lot within the Parking Easement; and

WHEREAS, The Buyer has requested that the City allow reservation of the southerly twenty (20) feet of Lot 6 for a driveway, widening out further to the south along the frontage on Glendale Road where Lot 6 widens, but a minimum of 20 feet in width at all points, as the permanent location of the driveway (“the driveway area”); and

WHEREAS, With the driveway area reserved for the driveway to the house to be constructed on Lot 6, the City will maintain enough land for a three-car parking lot while ensuring that the City parking does not block said driveway area.

Ordered, that

City Council hereby releases the retained (non-Article 97) interest of the City in the above-described driveway area for the placement of a driveway to Lot 6, which shall be the permanent location of such driveway. The right to place a three-car parking lot, as provided in the deed recorded in the Hampshire Registry of Deeds, Book 7271, Page 216, shall hereby be limited to areas outside the driveway area as released hereby.

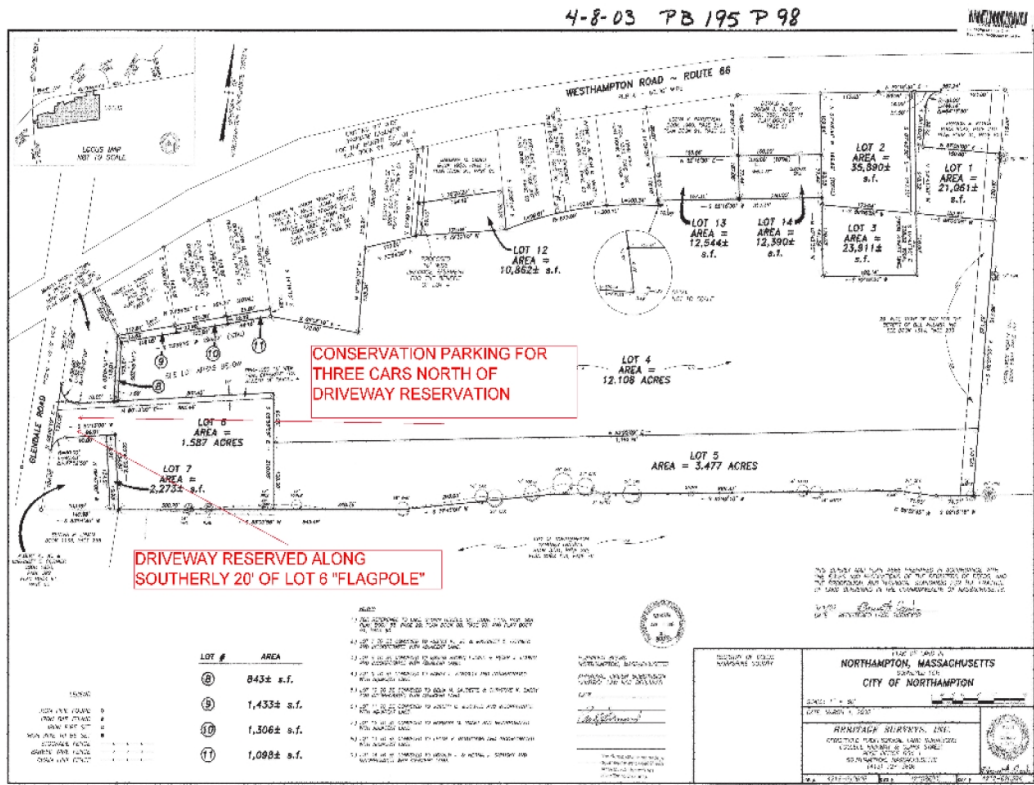

Rules suspended, passed two readings and enrolled.

**Financial Orders (in 2nd reading)
21.194 Order to Rescind Borrowing Authority - 3 Votes - 2nd reading**

**Financial Orders (in 2nd reading)
21.194 An Order to Rescind Borrowing Authority - 3 Votes - 2nd reading**
Councilor Dwight moved to approve the order in second reading. Councilor Thorpe seconded. The motion passed unanimously 9:0 by roll call vote.

The following order passed two readings:

City of Northampton
MASSACHUSETTS

In City Council February 18, 2021

Upon recommendation of the Mayor

21.194 An Order to Rescind Borrowing Authority - 3 Votes

Ordered, that

the City Council rescind the following orders because such borrowing authority is no longer necessary:

Order 20.075: \$150,000 of borrowing authority authorized under the loan order approved on July 9, 2021 to acquire land on Boggy Meadow Road to add to the Broad Brook –Fitzgerald Lake Greenway as the borrowing authority is no longer needed.

Order 17.272: \$1,630,000 of borrowing authority authorized under the loan order approved on April 20, 2017 for engineering and construction of repairs at the Ryan Reservoir as the project schedule and overall cost estimate is being reevaluated.

Order 17.272: \$250,000 of borrowing authority authorized under the loan order approved on April 20, 2017 for engineering and construction work related to rehabilitation and replacement of the city’s primary water main transmission line as the project schedule and overall cost is being reevaluated.

Passed two readings and enrolled.

21.195 Order to Appropriate Free Cash for COVID Expenses Potentially Ineligible for CARES Act Reimbursement -2nd reading

21.195 An Order to Appropriate Free Cash for COVID Expenses Potentially Ineligible for CARES Act Reimbursement - 2nd reading
Councilor LaBarge moved to approve the order in second reading. Councilor Maiore seconded. The motion passed unanimously 9:0 by roll call vote.

The following order passed two readings:

**City of Northampton
MASSACHUSETTS**

In City Council _____ February 18, 2021

Upon recommendation of the Mayor

21.195 An Order to Appropriate Free Cash for COVID Expenses Potentially Ineligible for CARES Act Reimbursement

Ordered, that

the sum of \$197,669 be appropriated from the FY2021 General Fund Undesignated Fund Balance (Free Cash) to cover costs related to the city’s response to the COVID-19 pandemic should they ultimately be deemed ineligible for reimbursement under the CARES Act program.

Passed two readings and enrolled.

21.196 An Order to Surplus 56 Vernon Street and Lease for Continued Use as Head Start Daycare and Early Education Facility - 2nd reading
Councilor LaBarge moved to approve the order in second reading. Councilor Maiore seconded. The motion passed unanimously 9:0 by roll call vote.

The following order passed two readings:

21.196 Order to Surplus 56 Vernon Street and Lease for Continued Use as Head Start Day-care and Early Education

Facility - 2nd reading

City of Northampton
MASSACHUSETTS

In City Council

February 18, 2021

Upon recommendation of the Mayor

21.196 An Order to Surplus 56 Vernon Street and Lease for Continued Use as Head Start Daycare and Early Education Facility

Ordered, that

Whereas, the City of Northampton owns a property located at 56 Vernon Street known as the former Vernon Street School, and shown on Assessors Map 31A, Parcel 112, Lot 1; and;

Whereas, In 1977, Northampton Mayor Harry Chapman executed the first lease on the former Vernon Street School property at 56 Vernon Street to Hampshire Community Action Corporation (HCAC), converting the former neighborhood elementary school into a Head Start daycare facility; and;

Whereas, Mayors Musante, Ford, Higgins, and Narkewicz, with the approval of the then-sitting City Councils, have continued that use, recognizing the value to our community and region of providing high-quality Head Start and early care and education services for low and moderate-income children; and;

Whereas, the current lease with Community Action Pioneer Valley (CAPV) is set to expire on November 20, 2023, the building is in need of additional capital improvements, and long term control of the property is a condition of eligibility for federal Head Start capital grant funding; and;

Whereas, the City of Northampton does not have a municipal use for the property and M.G.L. c. 30B, §16 requires a vote of City Council to surplus any interest in public property; and so

Now therefore be it ordered that,

The property at 56 Vernon Street is declared surplus to City of Northampton needs and is hereby transferred to the care, custody, and control of the Mayor for the purpose of leasing said property for thirty (30) years at a nominal amount with the restriction that the property can only be used for Head Start and early care and education and other related services by a 501(c)(3) non-profit organization on such terms and conditions as the Mayor deems appropriate, provided that and the lessee shall be responsible for all utilities, maintenance, repair, and replacement of all mechanical systems. The lessee shall be required to maintain the structure in a safe condition for its continued use as a Head Start facility.

Passed two readings and enrolled.

Orders

Orders

None.

Ordinances

(Not Yet Referred)

21.198

Ordinance

Relative to a

Stop Sign on

Scanlon

Avenue

21.199

Ordinance

Relative to Stop

Signs on Cross

Street

Ordinances (Not Yet Referred)

21.198 An Ordinance Relative to a Stop Sign on Scanlon Avenue

21.199 An Ordinance Relative to Stop Signs on Cross Street

Councilor Dwight moved to refer ordinances 21.198 and 21.199 as a group to Legislative Matters. Councilor Jarrett seconded. The motion passed unanimously 9:0 by roll call vote.

<p><u>Ordinances</u></p>	<p><u>Ordinances</u> None.</p>
<p><u>New Business</u></p>	<p><u>New Business</u> None.</p>
<p><u>Information (Charter Provision 2-7) & Study Requests</u></p>	<p><u>Information (Charter Provision 2-7) and Information Study Requests</u> Councilor Dwight made a request to hold a discussion going forward around possible City Council rule changes and committee changes. He respectfully asked Councilor Sciarra to appoint a committee to study changes to the council rules and committees. Councilor Sciarra said she would take the request under advisement.</p>
<p><u>Motion to Adjourn</u></p>	<p>Upon motion made by Councilor Foster and seconded by Councilor Maiore, the meeting was adjourned at 10:57 p.m. The motion carried unanimously 9:0 by roll call vote. Attest: _____ Administrative Assistant to the City Council</p>



MAYOR DAVID J. NARKEWICZ

City of Northampton

Office of the Mayor

210 Main Street Room 12

Northampton, MA 01060-3199

(413) 587-1249 Fax: (413) 587-1275

mayor@northamptonma.gov

DATE: March 4, 2021

TO: City Council

FROM: Mayor David J. Narkewicz

SUBJECT: Appointments to Boards, Committees, and Commissions

Please find the attached appointments to City Boards, Committees, and Commissions:

Planning Board

David Whitehill (Full Member), 60 Washington Avenue, Northampton

Term: March 2021-June 2022

To fill the term of resigned full member, Alan Verson



Online Form Submittal: Application for Appointment to Boards, Committees and Commissions

noreply@civicplus.com <noreply@civicplus.com>

Thu, Aug 15, 2019 at 9:44 AM

To: mayor@northamptonma.gov

Application for Appointment to Boards, Committees and Commissions

City of Northampton Application for Appointment to Boards, Committees, and Commissions

Please return the completed form to: Mayor@northamptonma.gov or David J. Narkewicz, Mayor 210 Main Street, Northampton, MA 01060

First Name	David
Last Name	Whitehill
Title, if applicable	<i>Field not completed.</i>
Address1	60 Washington Ave
Address2	<i>Field not completed.</i>
City	Northampton
State	MA
Zip	01060
Home Phone	3475142567
Work Phone	<i>Field not completed.</i>
Cell Phone	<i>Field not completed.</i>
Occupation & Place of Employment	Architect - Kliment Halsband Architects
Email	davidwhitehill@gmail.com
Are you a Northampton resident?	Yes
Years Lived in Northampton	6
Age	40 - 49

Sex	<i>Field not completed.</i>
Racial / Ethnic Background	caucasian
Boards and Committees	Planning Board
Please list "other" board or committee of interest	<i>Field not completed.</i>
What skills and experience will you bring to this committee assignment?	<p>I am an architect licensed in MA, CT, & NY, working primarily on institutional buildings and sites. I also have specialty in historic buildings, adaptive reuse, and complex zoning/landmarked sites. I have professional background in Urban Design as well.</p> <p>I have an overriding interest in a urban future that focuses on: Pedestrian-friendly environments Safe Bike lanes Accessible sidewalks and streets Affordable and accessible housing, especially in the urban core A safe and resilient city for all Maintenance and a dynamic future for our historic buildings. Integration of a new Preservation Plan with the new Sustainable Northampton plan</p> <p>My wife Marissa and I have twin girls going into 3rd grade at JSS.</p>
Are you currently serving or have you served on any city committee?	Yes
Please list other city committees you have served on	Community Preservation Committee 2016-current (term ends 12/2019)
<p>Required: Please read the following, by signing below you state that you understand and agree.</p> <p><i>The filing of this form does not guarantee my appointment. An application is kept on file for two (2) years; after that I must file a new application. Being appointed to a committee, board, or commission means that I am considered a Municipal Employee under MGL Chapter 268A and thereby subject to Conflict of Interest Law MGL Chapter 268A, Financial Disclosure Law MGL Chapter 268B, as well as Open Meeting Law MGL Chapter 39: Section 23B. I understand that I will take the conflict of interest test after being appointed and that I also must be sworn in by the City Clerk. I will contact the appointing authority with any questions about my service. Important: Once this form is submitted it becomes a public document, if there is information you do not want open to the public please do not include it on this form.</i></p>	
Signature	David Whitehill
Date	8/15/2019



MAYOR DAVID J. NARKEWICZ

City of Northampton

Office of the Mayor

210 Main Street Room 12

Northampton, MA 01060-3199

(413) 587-1249 Fax: (413) 587-1275

mayor@northamptonma.gov

DATE: March 18, 2021

TO: City Council

FROM: Mayor David J. Narkewicz

SUBJECT: Appointments to Boards, Committees, and Commissions

Please find the attached appointments to City Boards, Committees, and Commissions:

Planning Board

Samuel Taylor (Full Member), 245 North Street, Northampton

Term: July 2020-June 2023

Reappointment



Online Form Submittal: Application for Appointment to Boards, Committees and Commissions

1 message

noreply@civicplus.com <noreply@civicplus.com>
To: mayor@northamptonma.gov

Thu, Mar 11, 2021 at 5:25 PM

Application for Appointment to Boards, Committees and Commissions

City of Northampton Application for Appointment to Boards, Committees, and Commissions

Please return the completed form to: Mayor@northamptonma.gov or David J. Narkewicz, Mayor 210 Main Street, Northampton, MA 01060

First Name	Samuel
Last Name	Taylor
Title, if applicable	<i>Field not completed.</i>
Address1	245 North st.
Address2	<i>Field not completed.</i>
City	Northampton
State	Ma
Zip	01060
Home Phone	<i>Field not completed.</i>
Work Phone	<i>Field not completed.</i>
Cell Phone	4135887421
Occupation & Place of Employment	<i>Field not completed.</i>
Email	samtaylor1@hotmail.com
Are you a Northampton resident?	Yes
Years Lived in Northampton	12
Age	40 - 49

Sex	Male
Racial / Ethnic Background	Black
Boards and Committees	Planning Board
Please list "other" board or committee of interest	<i>Field not completed.</i>
What skills and experience will you bring to this committee assignment?	I am a local builder, landlord and renter in Northampton
Are you currently serving or have you served on any city committee?	Yes
Please list other city committees you have served on	Northampton
<p>Required: Please read the following, by signing below you state that you understand and agree. <i>The filing of this form does not guarantee my appointment. An application is kept on file for two (2) years; after that I must file a new application. Being appointed to a committee, board, or commission means that I am considered a Municipal Employee under MGL Chapter 268A and thereby subject to Conflict of Interest Law MGL Chapter 268A, Financial Disclosure Law MGL Chapter 268B, as well as Open Meeting Law MGL Chapter 39: Section 23B. I understand that I will take the conflict of interest test after being appointed and that I also must be sworn in by the City Clerk. I will contact the appointing authority with any questions about my service. Important: Once this form is submitted it becomes a public document, if there is information you do not want open to the public please do not include it on this form.</i></p>	
Signature	Samuel Taylor
Date	3/11/2021

Email not displaying correctly? [View it in your browser.](#)

City of Northampton

AFFIDAVIT OF WAGE COMPLIANCE

Name of Business: Antiques Corner

Location of Business: 91 Loudville Road

The Northampton City Council, in determining whether to issue, re-issue, modify, suspend or revoke a license. under G.L. c. 140, shall require that a potential or current licensee certify that they are not subject to a federal or state criminal or civil judgment, administrative citation, order or final administrative determination resulting from a violation of G.L. c. 149, c. 151, or the Fair Labor Standards Act. The City Council may require a wage bond or insurance be posted by any potential licensee who does not certify that they are not subject to a federal or state criminal or civil judgment, administrative citation, order or final administrative determination resulting from a violation of G.L. c. 149, c. 151, or the Fair Labor Standards Act. Licensees that are subject to a state or federal debarment for violation of the above laws, either voluntarily or involuntarily, or that have been prohibited from contracting with the Commonwealth or any of its agencies or subdivisions shall be prohibited from holding, or continuing to hold, licenses issued under G.L. c. 140, for the entire period of debarment or other stated time period.

Applicants must check box 1 or box 2 as applicable and must sign this Form, certifying compliance with the requirements set out in this Form. This Form must be included with the application.

AFFIDAVIT: (V) (Choose 1 below)



This License applicant is not subject to a federal or state criminal or civil judgment, administrative citation, order or final administrative determination resulting from a violation of G.L. c. 149, c. 151, or the Fair Labor Standards Act within the last three years.



This License applicant is subject to a federal or state criminal or civil judgment, administrative citation, order or final administrative determination resulting from a violation of G.L. c. 149, c. 151, or the Fair Labor Standards Act within the last three years. This applicant will provide a wage bond or wage insurance for the period of the license.

(V) Louis M. Sparick
(Typed or printed name of applicant)

(V) Louis Sparick
(Signature)

City of Northampton
Application for Annual License

NORTHAMPTON, MASS., _____

To the Honorable City Council of the City of Northampton:

The undersigned respectfully petitions your honorable body for a License as follows:

Name of Business: **Antiques Corner**

Type of License: **Secondhand Dealer**

Location of Business: ⁸¹~~81~~ **Loudville Road**
81

Print Name of Applicant: (V) LOUIS M FARRICK

Signature of Applicant: (V) Louis M Farrick

Address of Applicant: (V) No. 81 Street LOUDVILLE RD

In City Council, _____

Referred to Committee on Licenses.

ATTEST:

City Clerk

In Committee on Licenses, _____

Voted to recommend that Petition ___ be
granted, _____ not granted

ATTEST:

Clerk

In City Council, _____ (date)

Voted that Petition be _____ granted
_____ not granted

Attest: _____ Clerk to City Council

City of Northampton

STATEMENT OF ALL TAXES FILED AND PAID

Name of Business: Antiques Corner

Location of Business: 91 Loudville Road

The license (as a/for a) Secondhand Dealer will not be issued unless this certification clause is signed by the applicant listed on the license.

I, (v) Louis M. FARRICK (print name of owner or authorized agent of the business) certify under the penalties of perjury that I, to my best knowledge and belief, have filed all state tax returns and paid all state taxes as required under law.

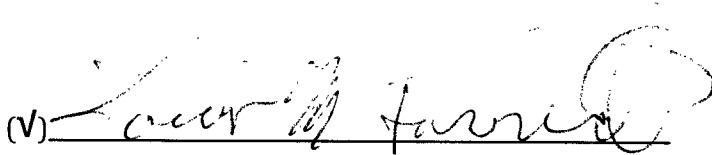
(v) 

Signature of Owner or Agent

(v)

12
or

(v)

Social Security Number

Federal Identification Number

Your social security number will be furnished to the Massachusetts Department of Revenue to determine whether you have met tax filing or tax payment obligations. Licenses who fail to correct their non-filing or delinquency will be subject to license suspension or revocation. This request is made under the authority of Massachusetts General Law, chapter 62C, section 49A.

City of Northampton
Application for Annual License

NORTHAMPTON, MASS., _____

To the Honorable City Council of the City of Northampton:

The undersigned respectfully petitions your honorable body for a License as follows:

Name of Business: Cumberland Rare Books

Type of License: Secondhand Dealer

Location of Business: 9-1/2 Market Street

Print Name of Applicant: (V) HOSEA BASKIN

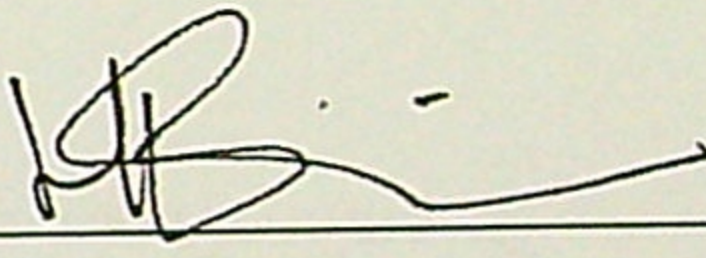
Signature of Applicant: (V) 

Address of Applicant: (V) No. 46 Street FRANKLIN ST

In City Council, _____

Referred to Committee on Licenses.

ATTEST:

City Clerk

In Committee on Licenses, _____

Voted to recommend that Petition ___be
granted, _____ not granted

ATTEST:

Clerk

In City Council, _____(date)

Voted that Petition be _____ granted
_____ not granted

Attest: _____ Clerk to City Council

City of Northampton

AFFADAVIT OF WAGE COMPLIANCE

Name of Business: Cumberland Rare Books

Location of Business: 9-1/2 Market Street

The Northampton City Council, in determining whether to issue, re-issue, modify, suspend or revoke a license. under G.L. c. 140, shall require that a potential or current licensee certify that they are not subject to a federal or state criminal or civil judgment, administrative citation, order or final administrative determination resulting from a violation of G.L. c. 149, c. 151, or the Fair Labor Standards Act. The City Council may require a wage bond or insurance be posted by any potential licensee who does not certify that they are not subject to a federal or state criminal or civil judgment, administrative citation, order or final administrative determination resulting from a violation of G.L. c. 149, c. 151, or the Fair Labor Standards Act. Licensees that are subject to a state or federal debarment for violation of the above laws, either voluntarily or involuntarily, or that have been prohibited from contracting with the Commonwealth or any of its agencies or subdivisions shall be prohibited from holding, or continuing to hold, licenses issued under G.L. c. 140, for the entire period of debarment or other stated time period.

Applicants must check box 1 or box 2 as applicable and must sign this Form, certifying compliance with the requirements set out in this Form. This Form must be included with the application.

AFFADAVIT: (V) (Choose 1 below)

This License applicant is not subject to a federal or state criminal or civil judgment, administrative citation, order or final administrative determination resulting from a violation of G.L. c. 149, c. 151, or the Fair Labor Standards Act within the last three years.

This License applicant is subject to a federal or state criminal or civil judgment, administrative citation, order or final administrative determination resulting from a violation of G.L. c. 149, c. 151, or the Fair Labor Standards Act within the last three years. This applicant will provide a wage bond or wage insurance for the period of the license.

(V)

HOSEA BASKIN

(Typed or printed name of applicant)

(V)

[Signature]

(Signature)

City of Northampton
Treasurer/Collector's Office
Permit Denial Form
Revised 11-30-2018

REQUESTED BY: **Pamela L. Powers, City Clerk**

Name of Person, Corporation or Business: **Cumberland Rare Books or Hosea Baskin**

Location of Property, Service or Address: **9-1/2 Market Street, Northampton, MA 01060**

All permits denied for outstanding amounts must receive confirmation of good standing from the Treasurer/Collector's Office PRIOR to issuance of the permit.

For Tax Collector's/Treasurer's Office Use Only

Please list below any tax, assessed to your office that is unpaid for twelve (12) months or more after its due date, unless there is a pending abatement or appeal before the Appellate Tax Board, for the person, corporation, or business entity noted above.

Accounts are current.

Signed: Kristine Bissell

Dated: April 5, 2021

THANK YOU!
CITY CLERK
NORTHAMPTON
210 MAIN ST., ROOM 4
(413) 587-1224

City of Northampton

Application for Annual License

04-01-2021
REG

14:41
000025

SECOND HAND
CHECK

\$25.00
\$25.00

NORTHAMPTON, MASS., _____

To the Honorable City Council of the City of Northampton:

The undersigned respectfully petitions your honorable body for a License as follows:

Name of Business: Electric Eye Records

Type of License: Secondhand Dealer

Location of Business: 52 Main St., #6

Print Name of Applicant: (V) Andrew CRESPO

Signature of Applicant: (V) [Handwritten Signature]

Address of Applicant: (V) No. 52 Street MAIN ST. #6

In City Council, _____

Referred to Committee on Licenses.

ATTEST:

City Clerk

In Committee on Licenses, _____

Voted to recommend that Petition ___ be
granted, _____ not granted

ATTEST:

Clerk

In City Council, _____ (date)

Voted that Petition be _____ granted
_____ not granted

Attest: _____ Clerk to City Council

City of Northampton

STATEMENT OF ALL TAXES FILED AND PAID



Name of Business: Electric Eye Records

Location of Business: 52 Main St., #6

The license (as a/for a) *Secondhand Dealer* will not be issued unless this certification clause is signed by the applicant listed on the license.

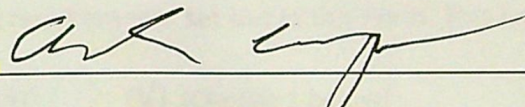
I, (V) Andrew Crespo (print name of owner or authorized agent of the business) certify under the penalties of perjury that I, to my best knowledge and belief, have filed all state tax returns and paid all state taxes as required under law.

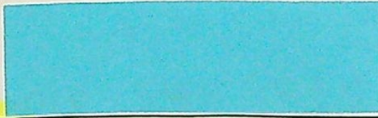
(V) 
Signature of Owner or Agent

(V)  or (V) 
Social Security Number Federal Identification Number

Your social security number will be furnished to the Massachusetts Department of Revenue to determine whether you have met tax filing or tax payment obligations. Licenses who fail to correct their non-filing or delinquency will be subject to license suspension or revocation. This request is made under the authority of Massachusetts General Law, chapter 62C, section 49A.

City of Northampton

AFFADAVIT OF WAGE COMPLIANCE

Name of Business: Electric Eye Records

Location of Business: 52 Main St., #6

The Northampton City Council, in determining whether to issue, re-issue, modify, suspend or revoke a license. under G.L. c. 140, shall require that a potential or current licensee certify that they are not subject to a federal or state criminal or civil judgment, administrative citation, order or final administrative determination resulting from a violation of G.L. c. 149, c. 151, or the Fair Labor Standards Act. The City Council may require a wage bond or insurance be posted by any potential licensee who does not certify that they are not subject to a federal or state criminal or civil judgment, administrative citation, order or final administrative determination resulting from a violation of G.L. c. 149, c. 151, or the Fair Labor Standards Act. Licensees that are subject to a state or federal debarment for violation of the above laws, either voluntarily or involuntarily, or that have been prohibited from contracting with the Commonwealth or any of its agencies or subdivisions shall be prohibited from holding, or continuing to hold, licenses issued under G.L. c. 140, for the entire period of debarment or other stated time period.

Applicants must check box 1 or box 2 as applicable and must sign this Form, certifying compliance with the requirements set out in this Form. This Form must be included with the application.

AFFADAVIT: (Choose 1 below)

This License applicant is not subject to a federal or state criminal or civil judgment, administrative citation, order or final administrative determination resulting from a violation of G.L. c. 149, c. 151, or the Fair Labor Standards Act within the last three years.

This License applicant is subject to a federal or state criminal or civil judgment, administrative citation, order or final administrative determination resulting from a violation of G.L. c. 149, c. 151, or the Fair Labor Standards Act within the last three years. This applicant will provide a wage bond or wage insurance for the period of the license.

Andrew Crespo

(Typed or printed name of applicant)

[Signature]

(Signature)

City of Northampton
Treasurer/Collector's Office
Permit Denial Form
Revised 11-30-2018

REQUESTED BY: **Pamela L. Powers, City Clerk**

Name of Person, Corporation or Business: **Electric Eye Records Andrew Crespo**

Location of Property, Service or Address: **52 Main St., #6, Florence, MA 01062**

All permits denied for outstanding amounts must receive confirmation of good standing from the Treasurer/Collector's Office PRIOR to issuance of the permit.

For Tax Collector's/Treasurer's Office Use Only

Please list below any tax, assessed to your office that is unpaid for twelve (12) months or more after its due date, unless there is a pending abatement or appeal before the Appellate Tax Board, for the person, corporation, or business entity noted above.

Tax accounts are current.

Signed: *Kristine Bissell*

Dated: April 5, 2021

City of Northampton
Application for Annual License

NORTHAMPTON, MASS., _____

To the Honorable City Council of the City of Northampton:

The undersigned respectfully petitions your honorable body for a License as follows:

Name of Business: **Norman E. Menard**

Type of License: **Secondhand Dealer**

Location of Business: **25 Garfield Avenue**

Print Name of Applicant: (V) Norman Menard

Signature of Applicant: (V) Norm E Menard

Address of Applicant: (V) No. 25 Street Garfield Ave Northampton, MA

In City Council, _____

Referred to Committee on Licenses.

ATTEST:

City Clerk

In Committee on Licenses, _____

Voted to recommend that Petition ___ be
granted, _____ not granted

ATTEST:

Clerk

In City Council, _____ (date)

Voted that Petition be _____ granted
_____ not granted

Attest: _____ Clerk to City Council

City of Northampton

STATEMENT OF ALL TAXES FILED AND PAID

Name of Business: Norman E. Menard

Location of Business: 25 Garfield Avenue

The license (as a/for a) Secondhand Dealer will not be issued unless this certification clause is signed by the applicant listed on the license.

I, Norman Menard (print name of owner or authorized agent of the business) certify under the penalties of perjury that I, to my best knowledge and belief, have filed all state tax returns and paid all state taxes as required under law.

Norm E Menard

Signature of Owner or Agent

Social Security Number

or _____

Federal Identification Number

Your social security number will be furnished to the Massachusetts Department of Revenue to determine whether you have met tax filing or tax payment obligations. Licenses who fail to correct their non-filing or delinquency will be subject to license suspension or revocation. This request is made under the authority of Massachusetts General Law, chapter 62C, section 49A.

City of Northampton

AFFIDAVIT OF WAGE COMPLIANCE

Name of Business: Norman E. Menard

Location of Business: 25 Garfield Avenue

The Northampton City Council, in determining whether to issue, re-issue, modify, suspend or revoke a license under G.L. c. 140, shall require that a potential or current licensee certify that they are not subject to a federal or state criminal or civil judgment, administrative citation, order or final administrative determination resulting from a violation of G.L. c. 149, c. 151, or the Fair Labor Standards Act. The City Council may require a wage bond or insurance be posted by any potential licensee who does not certify that they are not subject to a federal or state criminal or civil judgment, administrative citation, order or final administrative determination resulting from a violation of G.L. c. 149, c. 151, or the Fair Labor Standards Act. Licensees that are subject to a state or federal debarment for violation of the above laws, either voluntarily or involuntarily, or that have been prohibited from contracting with the Commonwealth or any of its agencies or subdivisions shall be prohibited from holding, or continuing to hold, licenses issued under G.L. c. 140, for the entire period of debarment or other stated time period.

Applicants must check box 1 or box 2 as applicable and must sign this Form, certifying compliance with the requirements set out in this Form. This Form must be included with the application.

AFFIDAVIT: (V) (Choose 1 below)



This License applicant is not subject to a federal or state criminal or civil judgment, administrative citation, order or final administrative determination resulting from a violation of G.L. c. 149, c. 151, or the Fair Labor Standards Act within the last three years.



This License applicant is subject to a federal or state criminal or civil judgment, administrative citation, order or final administrative determination resulting from a violation of G.L. c. 149, c. 151, or the Fair Labor Standards Act within the last three years. This applicant will provide a wage bond or wage insurance for the period of the license.

(V) Norman E. Menard

(Typed or printed name of applicant)

(V) Norman E. Menard

(Signature)

City of Northampton
Application for Annual License

NORTHAMPTON, MASS., _____

To the Honorable City Council of the City of Northampton:

The undersigned respectfully petitions your honorable body for a License as follows:

Name of Business: **Roz's Place**

Type of License: **Secondhand Dealer**

Location of Business: **6 Bridge Street**

Print Name of Applicant: (V) TIMOTHY SALDO

Signature of Applicant: (V) Timothy Saldo

Address of Applicant: (V) No. 6 BRIDGE Street NORTHAMPTON, MA 01060

In City Council, _____

Referred to Committee on Licenses.

ATTEST:

City Clerk

In Committee on Licenses, _____

Voted to recommend that Petition ___be
granted, _____ not granted

ATTEST:

Clerk

In City Council, _____ (date)

Voted that Petition be _____ granted
_____ not granted

Attest: _____ Clerk to City Council

City of Northampton

STATEMENT OF ALL TAXES FILED AND PAID

Name of Business: Roz's Place
Location of Business: 6 Bridge Street

The license (as a/for a) **Secondhand Dealer** will not be issued unless this certification clause is signed by the applicant listed on the license.

I, (v) TIMOTHY SALDO (print name of owner or authorized agent of the business) certify under the penalties of perjury that I, to my best knowledge and belief, have filed all state tax returns and paid all state taxes as required under law.

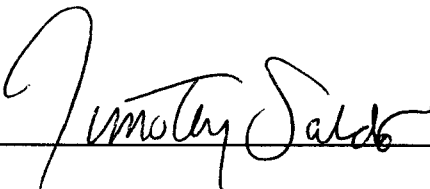
(v) 
Signature of Owner or Agent

(v) OR or (v) _____
Social Security Number Federal Identification Number

Your social security number will be furnished to the Massachusetts Department of Revenue to determine whether you have met tax filing or tax payment obligations. Licenses who fail to correct their non-filing or delinquency will be subject to license suspension or revocation. This request is made under the authority of Massachusetts General Law, chapter 62C, section 49A.

City of Northampton

AFFADAVIT OF WAGE COMPLIANCE

Name of Business: Roz's Place

Location of Business: 6 Bridge Street

The Northampton City Council, in determining whether to issue, re-issue, modify, suspend or revoke a license. under G.L. c. 140, shall require that a potential or current licensee certify that they are not subject to a federal or state criminal or civil judgment, administrative citation, order or final administrative determination resulting from a violation of G.L. c. 149, c. 151, or the Fair Labor Standards Act. The City Council may require a wage bond or insurance be posted by any potential licensee who does not certify that they are not subject to a federal or state criminal or civil judgment, administrative citation, order or final administrative determination resulting from a violation of G.L. c. 149, c. 151, or the Fair Labor Standards Act. Licensees that are subject to a state or federal debarment for violation of the above laws, either voluntarily or involuntarily, or that have been prohibited from contracting with the Commonwealth or any of its agencies or subdivisions shall be prohibited from holding, or continuing to hold, licenses issued under G.L. c. 140, for the entire period of debarment or other stated time period.

Applicants must check box 1 or box 2 as applicable and must sign this Form, certifying compliance with the requirements set out in this Form. This Form must be included with the application.

AFFADAVIT: (V) (Choose 1 below)

- This License applicant is not subject to a federal or state criminal or civil judgment, administrative citation, order or final administrative determination resulting from a violation of G.L. c. 149, c. 151, or the Fair Labor Standards Act within the last three years.
- This License applicant is subject to a federal or state criminal or civil judgment, administrative citation, order or final administrative determination resulting from a violation of G.L. c. 149, c. 151, or the Fair Labor Standards Act within the last three years. This applicant will provide a wage bond or wage insurance for the period of the license.

(V) TIMOTHY SALDO
(Typed or printed name of applicant)

(V) *Timothy Saldo*
(Signature)

City of Northampton
Application for Annual License

NORTHAMPTON, MASS., _____

To the Honorable City Council of the City of Northampton:

The undersigned respectfully petitions your honorable body for a License as follows:

Name of Business: **Sassy Pants Vintage & Used Clothing**
Type of License: **Secondhand Dealer**
Location of Business: **2 Konz St. Unit 2 Northampton, MA 01060**

Print Name of Applicant: (v) Kathleen Molongoski

Signature of Applicant: (v) Kathleen Molongoski

Address of Applicant: (v) No 2 Konz Street Unit #4



In City Council, _____

Referred to Committee on Licenses.

ATTEST:

City Clerk

In Committee on Licenses, _____

Voted to recommend that Petition ___ be granted, _____ not granted

ATTEST:

Clerk

In City Council, _____ (date)

Voted that Petition be _____ granted
_____ not granted

Attest: _____ Clerk to City Council

City of Northampton

STATEMENT OF ALL TAXES FILED AND PAID

Name of Business: Sassy Pants Vintage & Used Clothing

Location of Business: 2 Conz St. Unit 2 Northampton, MA 01060

The license (as a/for a) Secondhand Dealer will not be issued unless this certification clause is signed by the applicant listed on the license.

I, (v) Kathleen Malongaski (print name of owner or authorized agent of the business) certify under the penalties of perjury that I, to my best knowledge and belief, have filed all state tax returns and paid all state taxes as required under law.

Kathleen Malongaski

Signature of Owner or Agent

(v)

OR
or (v)

Social Security Number

Federal Identification Number

Your social security number will be furnished to the Massachusetts Department of Revenue to determine whether you have met tax filing or tax payment obligations. Licenses who fail to correct their non-filing or delinquency will be subject to license suspension or revocation. This request is made under the authority of Massachusetts General Law, chapter 62C, section 49A.

City of Northampton

AFFADAVIT OF WAGE COMPLIANCE

Name of Business: Sassy Pants Vintage & Used Clothing

Location of Business: 2 Conz St. Unit 2 Northampton, MA 01060

The Northampton City Council, in determining whether to issue, re-issue, modify, suspend or revoke a license. under G.L. c. 140, shall require that a potential or current licensee certify that they are not subject to a federal or state criminal or civil judgment, administrative citation, order or final administrative determination resulting from a violation of G.L. c. 149, c. 151, or the Fair Labor Standards Act. The City Council may require a wage bond or insurance be posted by any potential licensee who does not certify that they are not subject to a federal or state criminal or civil judgment, administrative citation, order or final administrative determination resulting from a violation of G.L. c. 149, c. 151, or the Fair Labor Standards Act. Licensees that are subject to a state or federal debarment for violation of the above laws, either voluntarily or involuntarily, or that have been prohibited from contracting with the Commonwealth or any of its agencies or subdivisions shall be prohibited from holding, or continuing to hold, licenses issued under G.L. c. 140, for the entire period of debarment or other stated time period.

Applicants must check box 1 or box 2 as applicable and must sign this Form, certifying compliance with the requirements set out in this Form. This Form must be included with the application.

AFFADAVIT: (V) (Choose 1 below)



This License applicant is not subject to a federal or state criminal or civil judgment, administrative citation, order or final administrative determination resulting from a violation of G.L. c. 149, c. 151, or the Fair Labor Standards Act within the last three years.



This License applicant is subject to a federal or state criminal or civil judgment, administrative citation, order or final administrative determination resulting from a violation of G.L. c. 149, c. 151, or the Fair Labor Standards Act within the last three years. This applicant will provide a wage bond or wage insurance for the period of the license.

(V) Kathleen Malongaski
(Typed or printed name of applicant)

(V) Kathleen Malongaski
(Signature)



Kelsey Bean Samson
July 11, 2025

City of Northampton
Application for Annual License

NORTHAMPTON, MASS., _____

To the Honorable City Council of the City of Northampton:

The undersigned respectfully petitions your honorable body for a License as follows:

Name of Business: **The Family Jewels**
Type of License: **Secondhand Dealer**
Location of Business: **56 Green Street**

Print Name of Applicant: (V) Richard J. Stone

Signature of Applicant: (V) Richard J. Stone *see*

Address of Applicant: (V) No. 56 Street Green Street

In City Council, _____

Referred to Committee on Licenses.

ATTEST:

City Clerk

In Committee on Licenses, _____

Voted to recommend that Petition ___ be granted, _____ not granted

ATTEST:

Clerk

In City Council, _____ (date)

Voted that Petition be _____ granted
_____ not granted

Attest: _____ *Clerk to City Council*

City of Northampton

AFFADAVIT OF WAGE COMPLIANCE

Name of Business: The Family Jewels

Location of Business: 56 Green Street

The Northampton City Council, in determining whether to issue, re-issue, modify, suspend or revoke a license. under G.L. c. 140, shall require that a potential or current licensee certify that they are not subject to a federal or state criminal or civil judgment, administrative citation, order or final administrative determination resulting from a violation of G.L. c. 149, c. 151, or the Fair Labor Standards Act. The City Council may require a wage bond or insurance be posted by any potential licensee who does not certify that they are not subject to a federal or state criminal or civil judgment, administrative citation, order or final administrative determination resulting from a violation of G.L. c. 149, c. 151, or the Fair Labor Standards Act. Licensees that are subject to a state or federal debarment for violation of the above laws, either voluntarily or involuntarily, or that have been prohibited from contracting with the Commonwealth or any of its agencies or subdivisions shall be prohibited from holding, or continuing to hold, licenses issued under G.L. c. 140, for the entire period of debarment or other stated time period.

Applicants must check box 1 or box 2 as applicable and must sign this Form, certifying compliance with the requirements set out in this Form. This Form must be included with the application.

AFFADAVIT: (V) (Choose 1 below)

- This License applicant is not subject to a federal or state criminal or civil judgment, administrative citation, order or final administrative determination resulting from a violation of G.L. c. 149, c. 151, or the Fair Labor Standards Act within the last three years.
- This License applicant is subject to a federal or state criminal or civil judgment, administrative citation, order or final administrative determination resulting from a violation of G.L. c. 149, c. 151, or the Fair Labor Standards Act within the last three years. This applicant will provide a wage bond or wage insurance for the period of the license.

(V) Richard J. Stone
(Typed or printed name of applicant)

(V) Richard J. Stone pres.
(Signature)

City of Northampton

STATEMENT OF ALL TAXES FILED AND PAID

Name of Business: The Family Jewels

Location of Business: 56 Green Street

The license (as a/for a) **Secondhand Dealer** will not be issued unless this certification clause is signed by the applicant listed on the license.

I, (V) Richard J. Stone (print name of owner or authorized agent of the business) certify under the penalties of perjury that I, to my best knowledge and belief, have filed all state tax returns and paid all state taxes as required under law.

(V) Richard J. Stone Pres.
Signature of Owner or Agent

(V) _____ or (V)  _____
Social Security Number Federal Identification Number

Your social security number will be furnished to the Massachusetts Department of Revenue to determine whether you have met tax filing or tax payment obligations. Licenses who fail to correct their non-filing or delinquency will be subject to license suspension or revocation. This request is made under the authority of Massachusetts General Law, chapter 62C, section 49A.

MASSACHUSETTS

DRIVER'S
LICENSE



Operator's Photo



08/28/2020

548419363

05/29/2025

05/29/1943

NONE

1 STONE
2 RICHARD JEFFREY
3 73 LEXINGTON AV
4 HOLYOKE, MA 01040-2008

Richard J Stone

18 EYES HAZ
19 SEX M 16 HGT 6'-00"
5 DO 08/21/2020 Rev 02/22/2016

05/29/43

City of Northampton
Application for Annual License

NORTHAMPTON, MASS., _____

To the Honorable City Council of the City of Northampton:

The undersigned respectfully petitions your honorable body for a License as follows:

Name of Business: Packards
Type of License: Pool Tables-Weekdays
Location of Business: 14 Masonic Street

Print Name of Applicant: (V) ROBERT E. Mc GOVERN

Signature of Applicant: (V) *Robert E. McGovern*

Address of Applicant: (V) No. 53 Street MAIN ST, HATFIELD, MA. 01038

In City Council, _____

Referred to Committee on Licenses.

ATTEST:

City Clerk

In Committee on Licenses, _____

Voted to recommend that Petition ___be
granted, _____ not granted

ATTEST:

Clerk

In City Council, _____(date)

Voted that Petition be _____ granted
_____ not granted

Attest: _____ Clerk to City Council

City of Northampton

STATEMENT OF ALL TAXES FILED AND PAID

Name of Business: Packards
Location of Business: 14 Masonic Street

The license (as a/for a) *Pool Tables-Sunday* will not be issued unless this certification clause is signed by the applicant listed on the license.

I, (V) ROBERT E. Mc GOVERN (print name of owner or authorized agent of the business) certify under the penalties of perjury that I, to my best knowledge and belief, have filed all state tax returns and paid all state taxes as required under law.

(V) *Robert E. McGovern*

Signature of Owner or Agent

(V) _____

Social Security Number

OR

(V)  _____

Federal Identification Number

Your social security number will be furnished to the Massachusetts Department of Revenue to determine whether you have met tax filing or tax payment obligations. Licenses who fail to correct their non-filing or delinquency will be subject to license suspension or revocation. This request is made under the authority of Massachusetts General Law, chapter 62C, section 49A.

City of Northampton

AFFIDAVIT OF WAGE COMPLIANCE

Name of Business: Packards

Location of Business: 14 Masonic Street

The Northampton City Council, in determining whether to issue, re-issue, modify, suspend or revoke a license. under G.L. c. 140, shall require that a potential or current licensee certify that they are not subject to a federal or state criminal or civil judgment, administrative citation, order or final administrative determination resulting from a violation of G.L. c. 149, c. 151, or the Fair Labor Standards Act. The City Council may require a wage bond or insurance be posted by any potential licensee who does not certify that they are not subject to a federal or state criminal or civil judgment, administrative citation, order or final administrative determination resulting from a violation of G.L. c. 149, c. 151, or the Fair Labor Standards Act. Licensees that are subject to a state or federal debarment for violation of the above laws, either voluntarily or involuntarily, or that have been prohibited from contracting with the Commonwealth or any of its agencies or subdivisions shall be prohibited from holding, or continuing to hold, licenses issued under G.L. c. 140, for the entire period of debarment or other stated time period.

Applicants must check box 1 or box 2 as applicable and must sign this Form, certifying compliance with the requirements set out in this Form. This Form must be included with the application.

AFFIDAVIT: (Choose 1 below)

- This License applicant is not subject to a federal or state criminal or civil judgment, administrative citation, order or final administrative determination resulting from a violation of G.L. c. 149, c. 151, or the Fair Labor Standards Act within the last three years.
- This License applicant is subject to a federal or state criminal or civil judgment, administrative citation, order or final administrative determination resulting from a violation of G.L. c. 149, c. 151, or the Fair Labor Standards Act within the last three years. This applicant will provide a wage bond or wage insurance for the period of the license.

ROBERT E. Mc GOVERN
(Typed or printed name of applicant)

[Signature]
(Signature)

City of Northampton
Treasurer/Collector's Office
Permit Denial Form
Revised 11-30-2018

REQUESTED BY: **Pamela L. Powers, City Clerk**

Name of Person, Corporation or Business: **Packards or Weasel Real Estate Mgmt LLC**

Location of Property, Service or Address: **14 Masonic Street, Northampton, MA 01060**

All permits denied for outstanding amounts must receive confirmation of good standing from the Treasurer/Collector's Office PRIOR to issuance of the permit.

For Tax Collector's/Treasurer's Office Use Only

Please list below any tax, assessed to your office that is unpaid for twelve (12) months or more after its due date, unless there is a pending abatement or appeal before the Appellate Tax Board, for the person, corporation, or business entity noted above.

There are no unpaid amounts for twelve months or more after the due date.

Signed: Kristine Bissell

Dated: April 5, 2021

City of Northampton
Application for Annual License

NORTHAMPTON, MASS., _____

To the Honorable City Council of the City of Northampton:

The undersigned respectfully petitions your honorable body for a License as follows:

Name of Business: Packards
Type of License: Pool Tables-Sunday
Location of Business: 14 Masonic Street

Print Name of Applicant: (V) ROBERT E. Mc GOVERN

Signature of Applicant: (V) [Handwritten Signature]

Address of Applicant: (V) No. 53 Street MAIN ST. HATFIELD, MA 01038

In City Council, _____

Referred to Committee on Licenses.

ATTEST:

City Clerk

In Committee on Licenses, _____

Voted to recommend that Petition ___ be granted, _____ not granted

ATTEST:

Clerk

In City Council, _____ (date)

Voted that Petition be _____ granted
_____ not granted

Attest: _____ Clerk to City Council

City of Northampton

STATEMENT OF ALL TAXES FILED AND PAID

Name of Business: Packards
Location of Business: 14 Masonic Street

The license (as a/for a) Pool Tables-Sunday will not be issued unless this certification clause is signed by the applicant listed on the license.

I, (V) ROBERT E. Mc GOVERN (print name of owner or authorized agent of the business) certify under the penalties of perjury that I, to my best knowledge and belief, have filed all state tax returns and paid all state taxes as required under law.

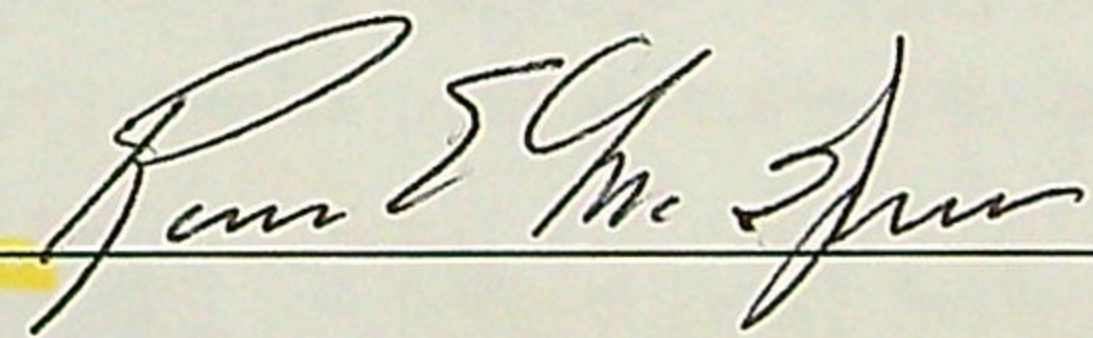
(V) 

Signature of Owner or Agent

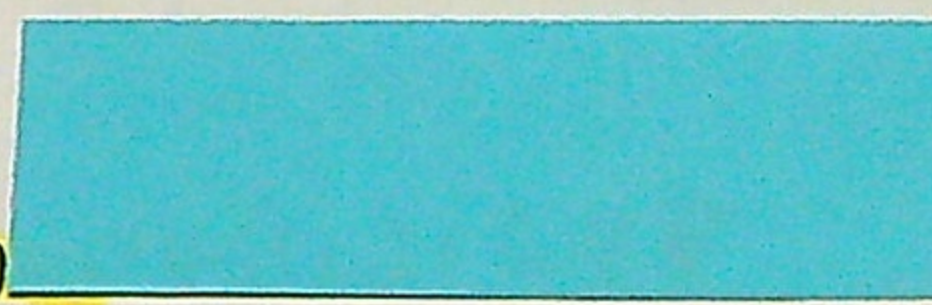
(V) _____ or (V) 

Social Security Number

Federal Identification Number

Your social security number will be furnished to the Massachusetts Department of Revenue to determine whether you have met tax filing or tax payment obligations. Licenses who fail to correct their non-filing or delinquency will be subject to license suspension or revocation. This request is made under the authority of Massachusetts General Law, chapter 62C, section 49A.

City of Northampton

AFFADAVIT OF WAGE COMPLIANCE

Name of Business: Packards
Location of Business: 14 Masonic Street

The Northampton City Council, in determining whether to issue, re-issue, modify, suspend or revoke a license. under G.L. c. 140, shall require that a potential or current licensee certify that they are not subject to a federal or state criminal or civil judgment, administrative citation, order or final administrative determination resulting from a violation of G.L. c. 149, c. 151, or the Fair Labor Standards Act. The City Council may require a wage bond or insurance be posted by any potential licensee who does not certify that they are not subject to a federal or state criminal or civil judgment, administrative citation, order or final administrative determination resulting from a violation of G.L. c. 149, c. 151, or the Fair Labor Standards Act. Licensees that are subject to a state or federal debarment for violation of the above laws, either voluntarily or involuntarily, or that have been prohibited from contracting with the Commonwealth or any of its agencies or subdivisions shall be prohibited from holding, or continuing to hold, licenses issued under G.L. c. 140, for the entire period of debarment or other stated time period.

Applicants must check box 1 or box 2 as applicable and must sign this Form, certifying compliance with the requirements set out in this Form. This Form must be included with the application.

AFFADAVIT: (Choose 1 below)

- This License applicant is not subject to a federal or state criminal or civil judgment, administrative citation, order or final administrative determination resulting from a violation of G.L. c. 149, c. 151, or the Fair Labor Standards Act within the last three years.
- This License applicant is subject to a federal or state criminal or civil judgment, administrative citation, order or final administrative determination resulting from a violation of G.L. c. 149, c. 151, or the Fair Labor Standards Act within the last three years. This applicant will provide a wage bond or wage insurance for the period of the license.

(V) ROBERT E. Mc GOVERN
(Typed or printed name of applicant)

(V) [Signature]
(Signature)

City of Northampton
Treasurer/Collector's Office
Permit Denial Form
Revised 11-30-2018

REQUESTED BY: **Pamela L. Powers, City Clerk**

Name of Person, Corporation or Business: **Packards or Weasel Real Estate Mgmt LLC**

Location of Property, Service or Address: **14 Masonic Street, Northampton, MA 01060**

All permits denied for outstanding amounts must receive confirmation of good standing from the Treasurer/Collector's Office PRIOR to issuance of the permit.

For Tax Collector's/Treasurer's Office Use Only

Please list below any tax, assessed to your office that is unpaid for twelve (12) months or more after its due date, unless there is a pending abatement or appeal before the Appellate Tax Board, for the person, corporation, or business entity noted above.

There are no unpaid amounts for twelve months or more after the due date.

Signed: Kristine Bissell

Dated: April 5, 2021

Adopted 5-21 1992 [Ch14 S.14-21 of the 1977 Code]
Denial/Revocation of License

City of Northampton

City of Northampton
Application for Annual License

NORTHAMPTON, MASS., _____

To the Honorable City Council of the City of Northampton:

The undersigned respectfully petitions your honorable body for a License as follows:

Name of Business: **Norman E. Menard**

Type of License: **Junk Dealer**

Location of Business: **25 Garfield Avenue**

Print Name of Applicant: (v) Norman Menard

Signature of Applicant: (v) Norm E Menard

Address of Applicant: (v) No. 25 Street Garfield Ave, No. MA

In City Council, _____

Referred to Committee on Licenses.

ATTEST:

City Clerk

In Committee on Licenses, _____

Voted to recommend that Petition ___ be
granted, _____ not granted

ATTEST:

Clerk

In City Council, _____ (date)

Voted that Petition be _____ granted
_____ not granted

Attest: _____ Clerk to City Council

City of Northampton

STATEMENT OF ALL TAXES FILED AND PAID

Name of Business: Norman E. Menard

Location of Business: 25 Garfield Avenue

The license (as a/for a) **Secondhand Dealer** will not be issued unless this certification clause is signed by the applicant listed on the license.

I, (v) Norman Menard (print name of owner or authorized agent of the business) certify under the penalties of perjury that I, to my best knowledge and belief, have filed all state tax returns and paid all state taxes as required under law.

(v) Norm E Menard

Signature of Owner or Agent

(v) _____ or (v) _____

Social Security Number

Federal Identification Number

Your social security number will be furnished to the Massachusetts Department of Revenue to determine whether you have met tax filing or tax payment obligations. Licenses who fail to correct their non-filing or delinquency will be subject to license suspension or revocation. This request is made under the authority of Massachusetts General Law, chapter 62C, section 49A.

City of Northampton

AFFIDAVIT OF WAGE COMPLIANCE

Name of Business: Norman E. Menard

Location of Business: 25 Garfield Avenue

The Northampton City Council, in determining whether to issue, re-issue, modify, suspend or revoke a license. under G.L. c. 140, shall require that a potential or current licensee certify that they are not subject to a federal or state criminal or civil judgment, administrative citation, order or final administrative determination resulting from a violation of G.L. c. 149, c. 151, or the Fair Labor Standards Act. The City Council may require a wage bond or insurance be posted by any potential licensee who does not certify that they are not subject to a federal or state criminal or civil judgment, administrative citation, order or final administrative determination resulting from a violation of G.L. c. 149, c. 151, or the Fair Labor Standards Act. Licensees that are subject to a state or federal debarment for violation of the above laws, either voluntarily or involuntarily, or that have been prohibited from contracting with the Commonwealth or any of its agencies or subdivisions shall be prohibited from holding, or continuing to hold, licenses issued under G.L. c. 140, for the entire period of debarment or other stated time period.

Applicants must check box 1 or box 2 as applicable and must sign this Form, certifying compliance with the requirements set out in this Form. This Form must be included with the application.

AFFIDAVIT: (V) (Choose 1 below)

- This License applicant is not subject to a federal or state criminal or civil judgment, administrative citation, order or final administrative determination resulting from a violation of G.L. c. 149, c. 151, or the Fair Labor Standards Act within the last three years.
- This License applicant is subject to a federal or state criminal or civil judgment, administrative citation, order or final administrative determination resulting from a violation of G.L. c. 149, c. 151, or the Fair Labor Standards Act within the last three years. This applicant will provide a wage bond or wage insurance for the period of the license.

(V) Norman E. Menard
(Typed or printed name of applicant)

(V) Norman E. Menard
(Signature)

THANK YOU!
CITY CLERK
NORTHAMPTON
210 MAIN ST, ROOM 4
(413) 587-1224

City of Northampton

Application for Annual License

04-01-2021 14:43
REG 000027

JUNK DEALERS \$50.00
CHECK \$50.00

NORTHAMPTON, MASS., _____

To the Honorable City Council of the City of Northampton:

The undersigned respectfully petitions your honorable body for a License as follows:

Name of Business: Richard & Sharon Huntley

Type of License: Junk Dealer

Location of Business: 254 Easthampton Road

Print Name of Applicant: (V) RICHARD HUNTLEY

Signature of Applicant: (V) [Handwritten Signature]

Address of Applicant: (V) No. PO BOX 172 Street LEEDS, MA 01053

In City Council, _____

Referred to Committee on Licenses.

ATTEST:

City Clerk

In Committee on Licenses, _____

Voted to recommend that Petition ___ be
granted, _____ not granted

ATTEST:

Clerk

In City Council, _____ (date)

Voted that Petition be _____ granted
_____ not granted

Attest: _____ Clerk to City Council

City of Northampton

AFFADAVIT OF WAGE COMPLIANCE

Name of Business: Richard & Sharon Huntley

Location of Business: 254 Easthampton Road

The Northampton City Council, in determining whether to issue, re-issue, modify, suspend or revoke a license. under G.L. c. 140, shall require that a potential or current licensee certify that they are not subject to a federal or state criminal or civil judgment, administrative citation, order or final administrative determination resulting from a violation of G.L. c. 149, c. 151, or the Fair Labor Standards Act. The City Council may require a wage bond or insurance be posted by any potential licensee who does not certify that they are not subject to a federal or state criminal or civil judgment, administrative citation, order or final administrative determination resulting from a violation of G.L. c. 149, c. 151, or the Fair Labor Standards Act. Licensees that are subject to a state or federal debarment for violation of the above laws, either voluntarily or involuntarily, or that have been prohibited from contracting with the Commonwealth or any of its agencies or subdivisions shall be prohibited from holding, or continuing to hold, licenses issued under G.L. c. 140, for the entire period of debarment or other stated time period.

Applicants must check box 1 or box 2 as applicable and must sign this Form, certifying compliance with the requirements set out in this Form. This Form must be included with the application.

AFFADAVIT: (Choose 1 below)

This License applicant is not subject to a federal or state criminal or civil judgment, administrative citation, order or final administrative determination resulting from a violation of G.L. c. 149, c. 151, or the Fair Labor Standards Act within the last three years.

This License applicant is subject to a federal or state criminal or civil judgment, administrative citation, order or final administrative determination resulting from a violation of G.L. c. 149, c. 151, or the Fair Labor Standards Act within the last three years. This applicant will provide a wage bond or wage insurance for the period of the license.

(V) RICHARD HUNTLEY
(Typed or printed name of applicant)

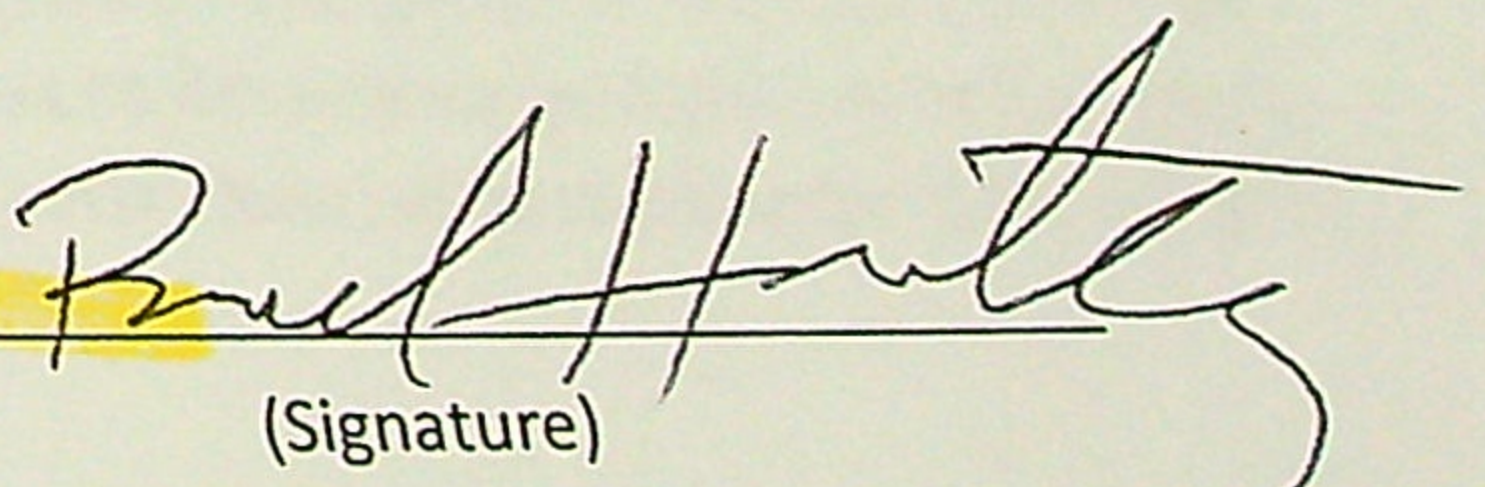
(V) 
(Signature)

City of Northampton

STATEMENT OF ALL TAXES FILED AND PAID

Name of Business: Richard & Sharon Huntley

Location of Business: 254 Easthampton Road

The license (as a/for a) Junk Dealer will not be issued unless this certification clause is signed by the applicant listed on the license.

I, RICHARD HUNTLEY (print name of owner or authorized agent of the business) certify under the penalties of perjury that I, to my best knowledge and belief, have filed all state tax returns and paid all state taxes as required under law.

Richard Huntley

Signature of Owner or Agent

Social Security Number

OR
or

Federal Identification Number

Your social security number will be furnished to the Massachusetts Department of Revenue to determine whether you have met tax filing or tax payment obligations. Licenses who fail to correct their non-filing or delinquency will be subject to license suspension or revocation. This request is made under the authority of Massachusetts General Law, chapter 62C, section 49A.

City of Northampton
Treasurer/Collector's Office
Permit Denial Form
Revised 11-30-2018

REQUESTED BY: **Pamela L. Powers, City Clerk**

Name of Person, Corporation or Business: **Richard & Sharon Huntley**

Location of Property, Service or Address: **254 Easthampton Road, Northampton, MA 01060**

All permits denied for outstanding amounts must receive confirmation of good standing from the Treasurer/Collector's Office PRIOR to issuance of the permit.

For Tax Collector's/Treasurer's Office Use Only

Please list below any tax, assessed to your office that is unpaid for twelve (12) months or more after its due date, unless there is a pending abatement or appeal before the Appellate Tax Board, for the person, corporation, or business entity noted above.

Tax accounts are current.

Signed: Kristine Bissell

Dated: April 5, 2021

Adopted 5-21 1992 [Ch14 S.14-21 of the 1977 Code]
Denial/Revocation of License

City of Northampton

City of Northampton

MASSACHUSETTS

In City Council, April 15, 2021

Upon the recommendation of Mayor David J. Narkewicz, Conservation Commission and Planning & Sustainability

21.244 An Order to Acquire and Amend Easements at the Mill River Greenway-Smith College

Ordered, that

- WHEREAS, The ***Open Space and Recreation Plan: 2018-2025*** recommends expanding public access along the Mill River as part of the ***Mill River Greenway*** and the ***Climate Resilience and Regeneration Plan (2021)*** recommends moving to renewable energy and electrification of thermal loads;
- WHEREAS, The Trustees of the Smith College granted the City an ***Open Space Restriction and Public Right of Way Easement*** recorded at Hampshire Registry of Deeds at Book 5900, Page 26 (3/14/2000) and Book 5898, Page 39 (3/9/2000);
- WHEREAS, The City of Northampton would like to revise this restriction to be a formal conservation restriction in accordance with MGL Chapter 184, Section 31;
- WHEREAS, Smith College would reserve the right to use area within 200 feet of the gravel road shown on a plan entitled "*Boundary Survey of Land of the Commonwealth of Massachusetts, formerly the Northampton State Hospital, Northampton, Massachusetts*" dated December 17, 1996 and recorded at Hampshire Registry of Deeds (Plan Book 183, Page 3, Sheet 3) for any parking uses. This area is currently allowed for parking for recreation uses and expanding to non-recreation uses will have no adverse impact on the conservation values;
- WHEREAS, Smith College would reserve the right for underground piping and heat exchange for ground sourced heat pumps on the premises so that, other than during construction, reconstruction, and repair activities, the facilities will not be visible above grade. This use is consistent with the City's *Climate Resilience and Regeneration Plan* and will have no adverse impact on conservation values;
- WHEREAS, Smith College is prepared to simultaneously expand the existing easement "to allow the public to pass and repass on foot trails for the purpose of fishing, hiking, winter sports..." to include all trails within 100 feet of the Mill River, on the northeasterly side of the Mill River, northerly and westerly of the Smith College crew house, and westerly of College Lane on the Smith College campus;

WHEREAS, The amendments of the open space restriction requires approval of the Massachusetts General Court under Article 97 of the Amendments to the State Constitution.

Ordered, that

The Mayor and the Conservation Commission is authorized to amend the existing ***Open Space Restriction and Public Right of Way Easement*** to expand the uses of existing parking areas, allow underground piping for ground source heat pumps, and accept the new expanded easement;

Further, the City requests and petitions that our legislative delegation file legislation substantially as follows:

An Act authorizing the City of Northampton to amend a certain conservation easement.

Be it enacted by the Senate and House of Representatives in General Court assembled, and by the authority of the same as follows:

SECTION 1. Notwithstanding any general or special law to the contrary, the city of Northampton, acting by and through its mayor and conservation commission, may amend the Open Space Restriction and Public Right of Way Easement recorded at Hampshire Registry of Deeds at Book 5900, Page 26 and Book 5898, Page 39 to allow any parking within 200 feet of the gravel road shown on a plan entitled "Boundary Survey of Land of the Commonwealth of Massachusetts, formerly the Northampton State Hospital, Northampton, Massachusetts" dated December 17, 1996 and recorded at Hampshire Registry of Deeds at Plan Book 183, Page 3, Sheet 3 and allow underground piping and heat exchange for ground source heat pumps and to record the new restriction as a conservation restriction under the authority of MGL Chapter 184, Section 31.

SECTION 2. As a condition and in consideration for the amendment to the easement as provided in section 1 of this act, and at the same time as such release, the city of Northampton, acting by and through its conservation commission, shall accept an expanded public right-of-way easement to allow the public to pass and repass on foot trails for the purpose of fishing, hiking, winter sports on all trails within 100 feet of the Mill River on the northerly side of the river, northerly and westerly of the Smith College crew house, and westerly of College Lane on the Smith College campus, Northampton.

City of Northampton
MASSACHUSETTS

In City Council, April 15, 2021

Upon the recommendation of the Community Preservation Committee
21.248 An Order to Appropriate CPA Funds for Historic Northampton Collections Storage

Ordered, that

WHEREAS, Historic Northampton, Inc. submitted a Small Grants application for Community Preservation Act funding to purchase appropriate collections storage for its ephemera, photograph and research collections;

WHEREAS, the collections yield important information about Northampton's history, and are frequently accessed for research by community members, businesses, and nonprofits;

WHEREAS, improved collections storage was a critical recommendation of the Massachusetts State Historic Records Board, and will protect these resources for the future;

WHEREAS, on February 17, 2021 the Northampton Community Preservation Committee, voted unanimously to recommend that \$3,000 in Community Preservation Act funds be used to support this project.

NOW, THEREFORE BE IT ORDERED,

That \$3,000 be appropriated from Community Preservation Act funding to Historic Northampton, Inc. for purchase and installation of new collections storage. And, that the grantee meets the conditions approved by the Community Preservation Committee, the Mayor, and City Council.

Specifically, \$3,000 is appropriated from the CPA Historic Preservation Reserve (account #2344930-359932).

City of Northampton

MASSACHUSETTS

In City Council, April 15, 2021

Upon the recommendation of the Community Preservation Committee

21.249 An Order to Appropriate \$120,000 in CPA Funds Toward Habitat Housing on Burts Pit Road

Ordered, that

WHEREAS, Pioneer Valley Habitat for Humanity submitted an application for Community Preservation Act funding for creation of three energy efficient affordable homes on Burts Pit Road;

WHEREAS, Habitat for Humanity has an excellent record of creating housing throughout the Pioneer Valley and beyond;

WHEREAS, the project has wide community support, leverages funding from many other sources, and utilizes volunteer labor;

WHEREAS, the homes will be permanently restricted to individuals and families earning 60% of area median income or below;

WHEREAS, on April 7, 2021, the Northampton Community Preservation Committee voted unanimously to recommend that \$120,000 in Community Preservation Act funds be used to support this project.

NOW, THEREFORE BE IT ORDERED,

That \$120,000 be appropriated from Community Preservation Act funding to Pioneer Valley Habitat for Humanity for the Broughton's Meadow Small Home Project. And, that the grantee meets the conditions approved by the Community Preservation Committee, the Mayor, and City Council.

Specifically, \$39,525 is appropriated from the CPA Budgeted Reserve (account #2344930-359930, and is \$80,475 allocated from the CPA Affordable Housing Reserve (account #2344930-359933)

City of Northampton
MASSACHUSETTS

In City Council, April 15, 2021

Upon the recommendation of the Community Preservation Committee

21.250 An Order to Appropriate \$14,500 in CPA Funds to Lilly Library Stair Repair Project

Ordered, that

WHEREAS, Lilly Library. submitted a CPA application for Community Preservation Act funding to conduct critical structural repairs to the historic entrance to the Library;

WHEREAS, all work will be consistent with the Secretary of the Interior Standards for the Treatment of Historic Properties;

WHEREAS, Lilly Library is an institution that has been an essential component of the Florence community for over 130 years, and this project will maintain the historic nature while ensuring continued functionality of the building;

WHEREAS, on April 7, 2021 the Northampton Community Preservation Committee, voted unanimously to recommend that \$14,500 in Community Preservation Act funds be used to support this project.

NOW, THEREFORE BE IT ORDERED,

That \$14,500 be appropriated from Community Preservation Act funding to Lilly Library for the Stair Repair project. And, that the grantee meets the conditions approved by the Community Preservation Committee, the Mayor, and City Council. Specifically, \$14,500 is appropriated from the CPA Historic Preservation Reserve (account #2344930-359932).

City of Northampton
MASSACHUSETTS

In City Council, April 15, 2021

Upon the recommendation of the Community Preservation Committee
21.251 An Order to Appropriate \$70,000 in CPA Funds for Historic Preservation Plan

Ordered, that

WHEREAS, the Office of Planning and Sustainability submitted an application for Community Preservation Act funding for creation of a Historic Preservation Plan to identify historic and cultural resources, assess current status, recognize issues and opportunities to help ensure that those resources are protected;

WHEREAS, through a collaborative community process and analysis of resource data and community values, the Plan will develop a vision, goal, priorities, and toolbox for preservation of priority historic and cultural resources and will become a component of the City's Sustainable Northampton Comprehensive Plan;

WHEREAS, on April 7, 2021, the Northampton Community Preservation Committee, voted unanimously to recommend that \$70,000 in Community Preservation Act funds be used to support this project.

NOW, THEREFORE BE IT ORDERED,

That \$70,000 be appropriated from Community Preservation Act funding to the Historic Preservation Plan. And, that the grantee meets the conditions approved by the Community Preservation Committee, the Mayor, and City Council.

Specifically, \$5,891 is allocated from the CPA Historic Preservation Reserve (account #2344930-359932), and \$64,109 is allocated from the CPA Budgeted Reserve (account #2344930-359930).

City of Northampton
MASSACHUSETTS

In City Council, April 15, 2021

Upon the recommendation of the Community Preservation Committee
21.252 An Order to Appropriate \$21,250 for Damon House/Shepherd Barn Project

Ordered, that

WHEREAS, Historic Northampton, Inc. submitted a CPA application for Community Preservation Act funding for restoration of the Damon House roofline balustrade, and for a structural analysis of the Shepherd Barn;

WHEREAS, all work will be consistent with the Secretary of the Interior's Standards for the Treatment of Historic Properties;

WHEREAS, CPA funds will be used to help secure an important historic resource that is valued by the community and the region, on which the City holds a permanent preservation restriction, and will expand Historic Northampton's public programming opportunities;

WHEREAS, on April 7, 2021 the Northampton Community Preservation Committee, voted unanimously to recommend that \$21,250 in Community Preservation Act funds be used to support this project.

NOW, THEREFORE BE IT ORDERED,

That \$21,250 be appropriated from Community Preservation Act funding to Historic Northampton, Inc. for the Shepherd/Damon project. And, that the grantee meets the conditions approved by the Community Preservation Committee, the Mayor, and City Council.

Specifically, \$21,250 is appropriated from the CPA Historic Preservation Reserve (account #2344930-359932).

City of Northampton
MASSACHUSETTS

In City Council, April 15, 2021

Upon the recommendation of the Community Preservation Committee

21.253 An Order to Appropriate \$60,000 in CPA Funds for Mill River Greenway Beach Project

Ordered, that

WHEREAS, the Northampton Conservation Commission and Office of Planning & Sustainability submitted a CPA application to acquire a 3.3 acre parcel along the Mill River in Leeds abutting the existing Mill River Greenway which includes recreational opportunities for all seasons;

WHEREAS, subject to the City successfully negotiating a conservation restriction which contains an adequate private party maintenance agreement;

WHEREAS, the project meets the goals of the Sustainable Northampton Plan, Northampton Community Preservation Plan, and Open Space, Recreation and Multi-use Trail Plan to protect open space, and provide recreational opportunities;

WHEREAS, on April 7, 2021, the Northampton Community Preservation Committee voted unanimously to recommend that \$60,000 in Community Preservation Act funds be used to support this project.

NOW, THEREFORE BE IT ORDERED,

That \$60,000 be appropriated from Community Preservation Act funding to the Northampton Conservation Commission and Office of Planning and Sustainability for the Mill River Greenway Beach acquisition Project. And, that the grantee meets the conditions approved by the Community Preservation Committee, the Mayor, and City Council.

Specifically, \$60,000 is appropriated from the CPA Budgeted Reserve (account #2344930-359930).

City of Northampton
MASSACHUSETTS

In City Council, April 15, 2021

Upon the recommendation of the Community Preservation Committee
21.254 An Order to Appropriate \$50,000 in CPA Funds to the Affordable Housing Fund

Ordered, that

WHEREAS, the Office of Planning and Sustainability submitted an application for Community Preservation Act funding for the Affordable Housing Fund;

WHEREAS, the fund will be used for due diligence and soft costs for predevelopment work necessary for new affordable housing opportunities that the City creates, and for which no other funds are readily available, and will help to leverage future funding opportunities from other sources;

WHEREAS, this fund will result in new affordable housing opportunities in Northampton, meets the goals of the Housing Needs Assessment and Strategic Plan, and will help to address impediments to fair housing identified in the Fair Housing Assessment;

WHEREAS, on April 7, 2021, the Northampton Community Preservation Committee, voted unanimously to recommend that \$50,000 in Community Preservation Act funds be used to support this project.

NOW, THEREFORE BE IT ORDERED,

That \$50,000 be appropriated from Community Preservation Act funding to the Affordable Housing Fund. And, that the grantee meets the conditions approved by the Community Preservation Committee, the Mayor, and City Council.

Specifically, \$50,000 is allocated from the CPA Affordable Housing Reserve (account #2344930-359933)

**Property Address:
Southeasterly Side of Brierwood Drive
Florence, MA**

ORDER OF TAKING

The undersigned, being the duly elected and sitting members of the City Council of the City of Northampton, in the Commonwealth of Massachusetts, acting under the authority of and in accordance with the provisions of General Laws of the Commonwealth, as from time to time amended, and more particularly Chapter 79, and pursuant to the Order of the Northampton City Council, a true copy of which is attached hereto as Exhibit A, does hereby take the parcel of land herein described in fee simple absolute for access to the R.K. Finn Ryan Road School.

The land taken herein is shown as Lot 31-A on a plan of land recorded in the Hampshire Registry of Deeds, Plan Book 67, Page 94, but specifically excepting and excluding the parcel of land shown as Lot 31-A on a plan recorded in Plan Book 65, Page 56A and also described in a deed recorded in Book 1486, Page 148.”

As pro tanto damages for the taking herein, the City of Northampton awards the sum of \$3,100.00, which shall be applied to reduce or release the tax lien encumbering such parcel.

For title see deed of Martin J. Beattie and Catherine C. Beattie to Edbert Homes, Inc., dated September 30, 1959, and recorded in the Hampshire Registry of Deeds Book 1312, Page 353.

[SIGNATURE PAGES FOLLOW]

IN WITNESS WHEREOF, We, the City Council of the City of Northampton, have executed this Order of Taking this _____ day of _____, 2021.

WITNESS TO ALL:

CITY COUNCIL, CITY OF NORTHAMPTON, MA

Gina-Louise Sciarra
AT-LARGE COUNCILOR

William H. Dwight
AT-LARGE COUNCILOR

Michael Quinlan, Jr.
WARD 1 COUNCILOR

Karen Foster
WARD 2 COUNCILOR

James Nash
WARD 3 COUNCILOR

John Thorpe
WARD 4 COUNCILOR

Alex Jarrett
WARD 5 COUNCILOR

Marianne L. LaBarge
WARD 6 COUNCILOR

Rachel Maiore
WARD 7 COUNCILOR

CERTIFICATE OF THE CLERK
CITY COUNCIL, CITY OF NORTHAMPTON, MA

I, Laura Krutzler, the Clerk of the City Council of the City of Northampton, MA, hereby certify that the attached Order of Taking of a certain parcel of land located in Northampton, Hampshire County, Massachusetts, was executed on _____, 2021, by Gina-Louise Sciarra, William H. Dwight, Michael Quinlan, Jr., Karen Foster, James Nash, John Thorpe, Alex Jarrett, Marianne L. LaBarge, and Rachel Maoire, who as of that day, were and are the duly elected members of the City Council of the City of Northampton, MA.

Signed this _____ day of _____, 2021.

Laura Krutzler
Clerk to City Council
City of Northampton, Massachusetts

EXHIBIT A
CITY COUNCIL ORDER

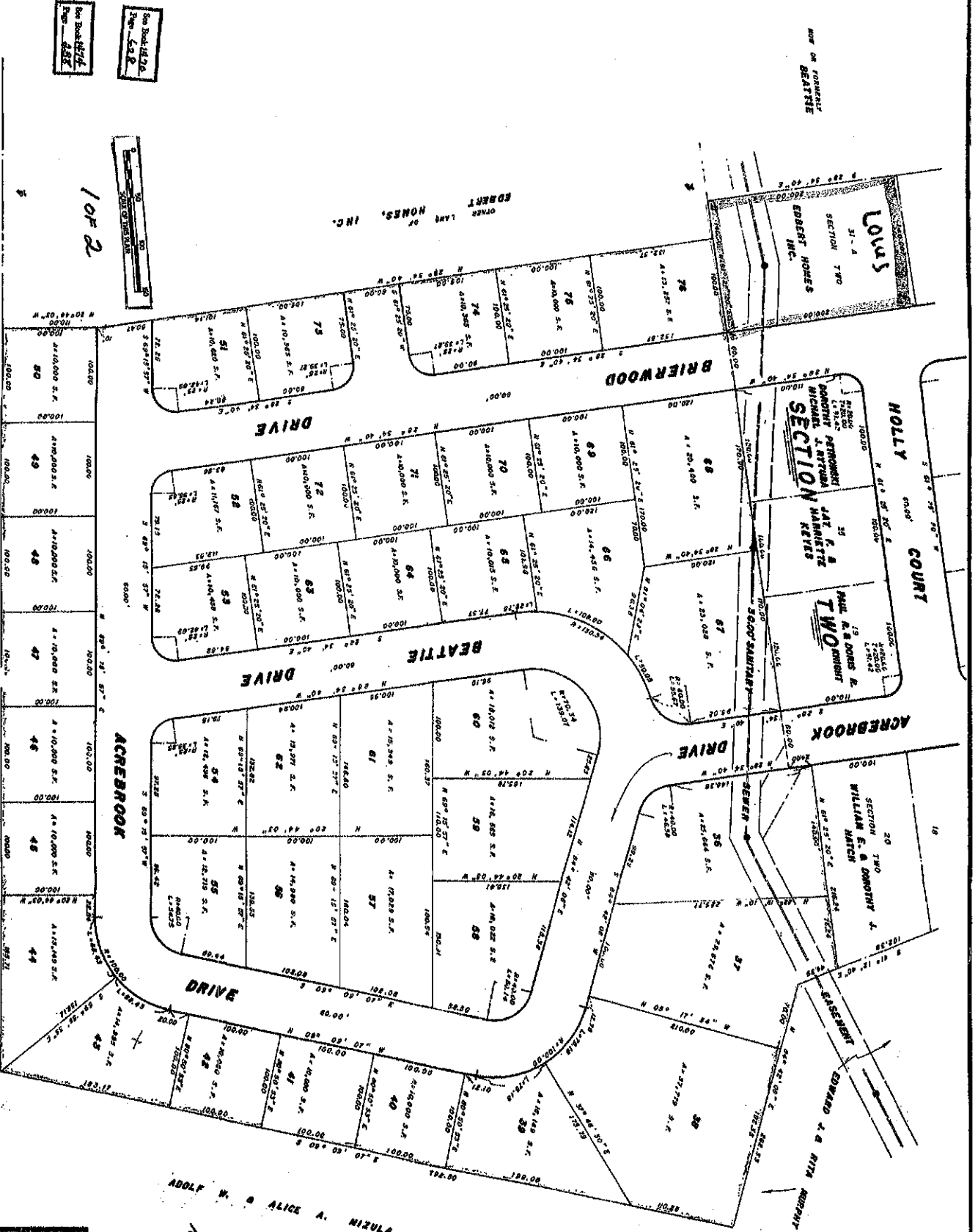

See Book 67 of
Plat 488

See Book 67 of
Plat 488

1 of 2

Robert Lamm
of
Robert Homes, Inc.
Plat 488

Norman B. Reed
Const. Co., Inc.

ADOLF W. & ALICE A. NIZULA

368-154

SECTION

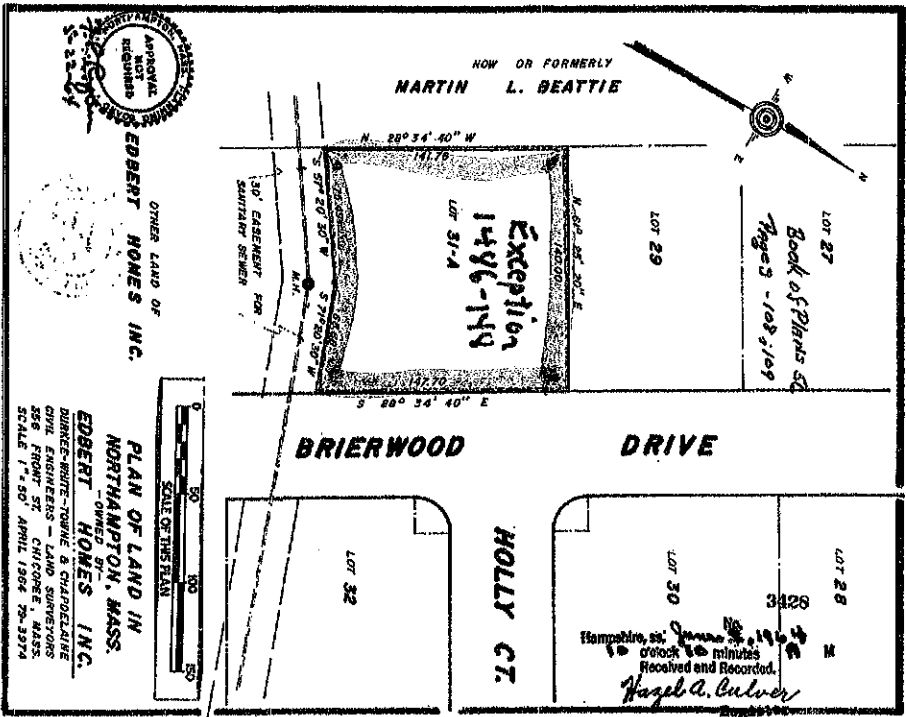

APPROVAL NOT REQUIRED
 EDBERT HOMES INC. ENGINEERS

OTHER LAND OF
 EDBERT HOMES INC.

PLAN OF LAND IN
 NORTHAMPTON, MASS.
 OWNED BY
 EDBERT HOMES INC.
 BURKE-WHITE-TOWNE & CHARDELIERE
 CIVIL ENGINEERS - LAND SURVEYORS
 228 FRONT ST. CHICOREE, MASS.
 SCALE 1" = 50' APRIL 1964 75-5374

SCALE OF FEET
 0 50 100 150

City of Northampton

MASSACHUSETTS

In City Council, April 15, 2021

Upon the recommendation of Mayor David J. Narkewicz and Department of Planning and Sustainability

**21.255 AN ORDER AUTHORIZING ACQUISITION OF A PARCEL OF LAND
ON THE SOUTHEASTERLY SIDE OF BRIERWOOD DRIVE**

WHEREAS, the parcel subject to this Order is located on the southeasterly side of Brierwood Drive and is shown on a plan of land entitled "Plan of Lots in Northampton, Mass. Owned by Edbert Homes, Inc.," dated July 12, 1965, and recorded in Hampshire Registry of Deeds in Plan Book 67, Pages 94-95, ("the Plan") being the southernly one-third of lot 31-A on the Plan ("the Parcel"); and

WHEREAS, the Parcel excludes that portion of lot 31-A that is shown on the plan entitled "Plan of Lots in Northampton, Mass. Owned by Edbert Homes, Inc.," dated April 1964, and recorded in the Hampshire Registry of Deeds in Plan Book 65, Page 56A, also shown thereon as lot 31-A; and

WHEREAS, the Parcel abuts the property of the R.K. Finn Ryan Road Elementary School; and

WHEREAS, the owner of the Parcel, Edbert Homes, Inc., was involuntarily dissolved by order of the Secretary of the Commonwealth in 1979; and

WHEREAS, the Parcel is subject to an existing tax lien for unpaid taxes that exceed the value of the Parcel; and

WHEREAS, the Parcel contains the layout of a City sewer line; and

WHEREAS, the Parcel would enhance access to the abutting school property from the neighborhood shown on the Plan.

NOW, THEREFORE BE IT ORDERED,

The City Council hereby authorizes the acquisition by purchase, gift, eminent domain, or otherwise of the Parcel described above for access to and egress from the land of the R.K. Finn Ryan Road Elementary School.

As damages for the taking, the City Council hereby awards Three Thousand One Hundred Dollars (\$3,100.00) which shall be applied to the outstanding balance on taxes due and owing on the Parcel.

NOTICE OF NONEXERCISE
City of Northampton Right Refusal/Option
G.L. c. 61A

OWNER: Robert A. Borawski and Ann M. Borawski
17 Audubon Road, Northampton, MA 01060
Book 7156, Page 275

Premises: Parcel A, **Plan Book 248, Page 90**
2.93 Acres +/-, off Kennedy Road

The City of Northampton hereby affirms that it has elected not to exercise its right of refusal/option to purchase the above referenced parcel after receipt of Notice of Sale from the above referenced Owner, in compliance with G.L. c. 61A, and release its lien and option to purchase from the lien in **Book 2413, Page 775**.

City of Northampton

Witness

By: _____
David Narkewicz, Mayor

Approved:

Alan Seewald, City Solicitor

COMMONWEALTH OF MASSACHUSETTS

County of Hampshire

On this ____ day of _____, 2021, before me, the undersigned notary public, personally appeared David Narkewicz, and proved to me through satisfactory evidence of identification, which was personal knowledge, to be the person whose name is signed on the preceding or attached document, and acknowledged to me that he signed it voluntarily for its stated purpose as the mayor of The City of Northampton as the voluntary act of such entity.

Notary Public
My Commission Expires:

CITY OF NORTHAMPTON
MASSACHUSETTS

In City Council

April 1, 2021

Upon recommendation of the Mayor

21.230 An Order to Reprogram Funds to AOM Fire Suppression and Leeds Elementary Parking Lot Repaving

Ordered, that

the following accounts with surplus funds be reprogrammed and added to the Academy of Music Fire Suppression System Project (19303 586229):

AOM Stage Lighting (19303 586311)	\$ 5,340.00
Municipal Building Elevator (19303 585501)	\$ 3,201.88
Fire Station Energy Management System (19303 586904)	\$12,352.30

the following account with surplus funds be reprogrammed and added to the Leeds Elementary School Parking Lot Repaving Project (19303 586815):

Leeds Chimney Repairs (19303 586705)	\$6809.50
--------------------------------------	-----------

City of Northampton
MASSACHUSETTS

In City Council

April 1, 2021

Upon recommendation of the Mayor

21.234 An Order to Accept DA Sullivan \$10,000 Gift to Fund Public Art Projects

Ordered, that

The Northampton City Council gratefully accepts the donation of \$10,000, a gift to the City of Northampton from D.A. Sullivan and Sons, Inc., and in accordance with Massachusetts General Law Chapter 44, Section 53A approves using the gifted funds to fund public art projects under the direction of the Northampton Arts and Culture Department.

City of Northampton
MASSACHUSETTS

In City Council

April 1, 2021

Upon recommendation of the Mayor

21.235 An Order to Appropriate Marijuana Community Impact Fee \$2.6 Million to Various Projects

Ordered, that

\$ 2,640,000 be appropriated from the Marijuana Community Impact Fee Stabilization Fund to the following accounts:

\$1,610,000	Community Resilience Hub Acquisition and Development
\$1,000,000	Pleasant Street Roadway and Streetscape Improvements from Hockanum Road to the Conz Street Roundabout
\$ 15,000	Accessible Bus Stop Design and Construction at 34 Bridge Street
\$ 15,000	Valley Bike Share Installation at 81 Conz Street (Salvo House)

City of Northampton
MASSACHUSETTS

In City Council

April 1, 2021

Upon recommendation of the Mayor

21.237 An Order to Appropriate Free Cash \$400,000 to Animal Control Facility

Ordered, that

the sum of \$400,000 be appropriated from the FY2021 General Fund Undesignated Fund Balance (Free Cash) to be added to the appropriation for the construction of an Animal Control Facility by Central Services originally funded in the FY2018 – FY2022 Capital Improvement Program.

CITY OF NORTHAMPTON
MASSACHUSETTS

In City Council,

April 1, 2021

Upon the recommendation of the Mayor

21.219 FY22 CIP – An Order to Authorize Borrowing \$6 Million for Radio System Upgrade

Ordered, that

\$6,000,000 is appropriated to pay costs of upgrading the city-wide radio system, including all costs incidental and related thereto; that to meet this appropriation, the Treasurer, with the approval of the Mayor, is authorized to borrow said amount under Chapter 44, Section 7(1) of the General Laws, or pursuant to any other enabling authority, and to issue bonds or notes of the City therefor; that the Mayor is authorized to take any action necessary or convenient to carry out this project; and that any premium received by the City upon the sale of any bonds or notes approved by this order, less any such premium applied to the payment of the costs of issuance of such bonds or notes, may be applied to the payment of costs of the project approved by this order in accordance with Chapter 44, Section 20 of the General Laws and thereby reduce the amount of the authorized borrowing by a like amount.

CITY OF NORTHAMPTON
MASSACHUSETTS

In City Council,

April 1, 2021

Upon the recommendation of the Mayor

21.220 FY22 CIP – An Order to Authorize Borrowing \$450,000 for Hotel Bridge

Ordered, that

\$450,000 is appropriated to pay costs of making structural and road surface improvements to the Hotel Bridge to accommodate bicycle and pedestrian traffic, including all costs incidental and related thereto; that to meet this appropriation, the Treasurer, with the approval of the Mayor, is authorized to borrow said amount under Chapter 44, Section 7(1) of the General Laws, or pursuant to any other enabling authority, and to issue bonds or notes of the City therefor; that the Mayor is authorized to take any action necessary or convenient to carry out this project; and that any premium received by the City upon the sale of any bonds or notes approved by this order, less any such premium applied to the payment of the costs of issuance of such bonds or notes, may be applied to the payment of costs of the project approved by this order in accordance with Chapter 44, Section 20 of the General Laws and thereby reduce the amount of the authorized borrowing by a like amount.

CITY OF NORTHAMPTON
MASSACHUSETTS

In City Council,

April 1, 2021

Upon the recommendation of the Mayor

21.221 FY22 CIP - An Order to Authorize Borrowing \$685,000 for DPW Vehicles

Ordered, that

\$685,000 is appropriated to pay costs of acquiring various vehicles and other equipment for the Department of Public Works, including all costs incidental and related thereto; that to meet this appropriation, the Treasurer, with the approval of the Mayor, is authorized to borrow said amount under Chapter 44, Section 7(1) of the General Laws, or pursuant to any other enabling authority, and to issue bonds or notes of the City therefor; that the Mayor is authorized to take any action necessary or convenient to carry out this project; and that any premium received by the City upon the sale of any bonds or notes approved by this order, less any such premium applied to the payment of the costs of issuance of such bonds or notes, may be applied to the payment of costs of the project approved by this order in accordance with Chapter 44, Section 20 of the General Laws and thereby reduce the amount of the authorized borrowing by a like amount.

City of Northampton
MASSACHUSETTS

In City Council

April 1, 2021

Upon recommendation of the Mayor

21.222 FY22 CIP - An Order to Appropriate \$500,000 from Capital Stabilization to Arch Street Bridge Repairs

Ordered, that

Pursuant to the FY2022-FY2026 Capital Improvement Program, that \$500,000 from the Capital Stabilization Fund be appropriated for repairs to the Arch Street Bridge in Leeds.

City of Northampton
MASSACHUSETTS

In City Council

April 1, 2021

Upon recommendation of the Mayor

21.223 FY22 CIP - An Order to Appropriate \$25,000 from Cemetery Perpetual Care for Cemetery Projects

Ordered, that

Pursuant to the FY2022-FY2026 Capital Improvement Program, that \$25,000 be appropriated from the Cemetery Trust and Income, to be used to fund restorative work at the city's cemeteries.

City of Northampton
MASSACHUSETTS

In City Council

April 1, 2021

Upon recommendation of the Mayor

21.224 FY22 CIP - An Order to Appropriate \$1.8 Million Free Cash to Various Projects

Ordered, that

Pursuant to the FY2022-FY2026 Capital Improvement Program, the following Capital Projects be appropriated from the FY2021 General Fund Undesignated Fund Balance (Free Cash):

Central Services – Academy of Music – Fire Suppression System Upgrades	\$ 150,000
Central Services – Senior Center – Paint Exterior of Building	\$ 118,000
Central Services – Florence Fire Station - Pave Rear Parking Lot	\$ 65,000
Central Services – Lighting Upgrades – Multiple City Facilities	\$ 110,000
Dispatch – Radio Positions Upgrades	\$ 150,000
IT – Northampton Public Schools – Wireless System Upgrade and Replacement	\$ 220,000
Planning – Comprehensive Planning	\$ 60,000
Fire Rescue – Replace 2007 Mechanic Plow Vehicle	\$ 65,000
Fire Rescue – Replace Cardiac Monitors in Four Ambulance Units	\$ 75,000
Northampton Public Schools – Replace 2005 – 30 Passenger Wheelchair Bus	\$ 55,000
Northampton Public Schools – JFK – Energy Management System	\$ 150,000
Northampton Public Schools – DW Facilities Assessment for Greenhouse Gas	\$ 60,000
Northampton Public Schools – NHS – Repoint Chimney	\$ 40,000
Smith Vocational and Agricultural High School – Building C Boiler Replacement	\$ 180,000
Smith Vocational and Agricultural High School – Nurses Office Renovation	\$ 206,000
<u>Department of Public Works – Sidewalks</u>	<u>\$ 175,000</u>
TOTAL:	\$ 1,879,000

City of Northampton
MASSACHUSETTS

In City Council

April 1, 2021

Upon recommendation of the Mayor

21.225 FY22 CIP - An Order to Appropriate \$150,000 from PEG Access Fund to IT Services Projects

Ordered, that

Pursuant to the FY2022-FY2026 Capital Improvement Program, that \$150,000 be appropriated from the PEG Access and Cable Related Fund (Fund 2337) to Information Technology Services for the following projects:

City Server System Replacement	\$ 100,000
Northampton Public Schools – Wireless System Upgrade and Replacement	\$ 50,000

City of Northampton
MASSACHUSETTS

In City Council

April 1, 2021

Upon recommendation of the Mayor

21.226 FY22 CIP - An Order to Appropriate \$115,000 from Parking Receipts Reserved for Parking Projects

Ordered, that

Pursuant to the FY2022-FY2026 Capital Improvement Program, that \$115,000 be appropriated from the Receipts Reserved for Appropriation – Parking to fund the following projects:

Replace 2011 Flatbed Truck for Parking Maintenance	\$ 60,000
EJ Gare Garage Repairs	\$ 25,000
Replace 2015 Nissan Leaf for Parking Enforcement	\$ 30,000

City of Northampton
MASSACHUSETTS

In City Council

April 1, 2021

Upon recommendation of the Mayor

**21.227 FY22 CIP - An Order to Appropriate \$215,000 from Sale of Land RRA Account for NPS
Projects**

Ordered, that

Pursuant to the FY2022-FY2026 Capital Improvement Program, \$215,000 be appropriated from the Receipts Reserved for Appropriation - Sale of Land Account (proceeds from the sale of the South Street School) to the following projects:

Northampton Public Schools – NHS – Replace Theater Fire Curtain	\$ 50,000
Northampton Public Schools – Leeds – Replace Handicap Lift in Cafeteria	\$ 100,000
Northampton Public Schools – Leeds – Floor Replacement	\$ 65,000

City of Northampton
MASSACHUSETTS

In City Council

April 1, 2021

Upon recommendation of the Mayor

21.229 FY22 CIP - An Order to Appropriate \$424,000 from Sale of Land RRA Account for Water Line Replacement

Ordered, that

Pursuant to the FY2022-FY2026 Capital Improvement Program, \$424,000 be appropriated from the Receipts Reserved for Appropriation - Sale of Land Account (proceeds from the sale of the Prospect Street Water Department Building) for the replacement of water lines throughout the city.

City of Northampton
MASSACHUSETTS

In City Council

April 1, 2021

Upon recommendation of the Mayor

21.229 FY22 CIP - An Order to Appropriate \$424,000 from Sale of Land RRA Account for Water Line Replacement

Ordered, that

Pursuant to the FY2022-FY2026 Capital Improvement Program, \$424,000 be appropriated from the Receipts Reserved for Appropriation - Sale of Land Account (proceeds from the sale of the Prospect Street Water Department Building) for the replacement of water lines throughout the city.

**CITY OF NORTHAMPTON
MASSACHUSETTS**

In the Year Two Thousand and Twenty-One

Upon the Recommendation of the Transportation and Parking Commission

**21.240
AN ORDINANCE**

**RELATIVE TO PARKING ON
FRONT STREET**

An Ordinance of the City of Northampton, Massachusetts. Be it ordained by the City Council of the City of Northampton, in City Council assembled, as follows:

SECTION 1

That the § 312-102 of the Code of Ordinances be amended as follows:

§ 312-102 Schedule I: Parking Prohibited All Times.

Location	Side	From	To
<u>Front Street</u>	<u>Westerly</u>	<u>Florence Street</u>	<u>Grove Avenue</u>
<u>Front Street</u>	<u>Easterly</u>	<u>Florence Street</u>	<u>Grove Avenue</u>

**CITY OF NORTHAMPTON
MASSACHUSETTS**

In the Year Two Thousand and Twenty-One

Upon the Recommendation of the Transportation and Parking Commission

**21.241
AN ORDINANCE**

**RELATIVE TO PARKING ON
GROVE AVENUE**

An Ordinance of the City of Northampton, Massachusetts. Be it ordained by the City Council of the City of Northampton, in City Council assembled, as follows:

SECTION 1

That the § 312-102 of the Code of Ordinances be amended as follows:

§ 312-102 Schedule I: Parking Prohibited All Times.

Location	Side	From	To
<u>Grove Avenue</u>	<u>Westerly</u>	<u>A point 50 feet southerly of Evergreen Road</u>	<u>Dead End</u>
<u>Grove Avenue</u>	<u>Easterly</u>	<u>Evergreen Road</u>	<u>Dead End</u>

SECTION 2

That the § 312-105 of the Code of Ordinances be amended as follows:

§ 312-105 Schedule IV: Seasonal Parking Restrictions.

Location	Side	From	To	Restriction
<u>Grove Avenue</u>	<u>Easterly</u>	<u>Evergreen Road</u>	<u>Front Street</u>	<u>No parking at any time from May 1 of any year to September 30 of the same year</u>

**CITY OF NORTHAMPTON
MASSACHUSETTS**

In the Year Two Thousand and Twenty-One

Upon the Recommendation of the Transportation and Parking Commission

**21.242
AN ORDINANCE**

**RELATIVE TO PARKING ON
FLORENCE STREET**

An Ordinance of the City of Northampton, Massachusetts. Be it ordained by the City Council of the City of Northampton, in City Council assembled, as follows:

SECTION 1

That the § 312-102 of the Code of Ordinances be amended as follows:

§ 312-102 Schedule I: Parking Prohibited All Times.

Location	Side	From	To
Florence Street	Westerly	Point opposite the northerly line of the sidewalk leading to the main entrance of the Leeds Grammar School <u>A point 424 feet south of Front Street</u>	Point 65 feet northerly <u>Δ point 578 feet south of Front Street</u>

**CITY OF NORTHAMPTON
MASSACHUSETTS**

In the Year Two Thousand and Twenty-One

Upon the Recommendation of the Transportation and Parking Commission

**21.243
AN ORDINANCE**

**RELATIVE TO PARKING ON
MAIN STREET (LEEDS)**

An Ordinance of the City of Northampton, Massachusetts. Be it ordained by the City Council of the City of Northampton, in City Council assembled, as follows:

SECTION 1

That the § 312-102 of the Code of Ordinances be amended as follows:

§ 312-102 Schedule I: Parking Prohibited All Times.

Location	Side	From	To
<u>Main Street (Leeds)</u>	<u>Easterly</u>	<u>Hotel Bridge</u>	<u>Arch Street</u>
<u>Main Street (Leeds)</u>	<u>Westerly</u>	<u>Hotel Bridge</u>	<u>Arch Street</u>

SECTION 2

That the § 312-105 of the Code of Ordinances be amended as follows:

§ 312-105 Schedule IV: Seasonal Parking Restrictions.

Location	Side	From	To	Restriction
<u>Main Street (Leeds)</u>	<u>Easterly</u>	<u>A point 306 feet southerly of Mulberry Street</u>	<u>Hotel Bridge</u>	<u>No parking at any time from May 1 of any year to September 30 of the same year</u>

**CITY OF NORTHAMPTON
MASSACHUSETTS**

In the Year Two Thousand and Twenty-One

Upon the Recommendation of the Transportation and Parking Commission

**21.198
AN ORDINANCE**

**RELATIVE TO A STOP SIGN ON
SCANLON AVENUE**

An Ordinance of the City of Northampton, Massachusetts. Be it ordained by the City Council of the City of Northampton, in City Council assembled, as follows:

SECTION 1

That the § 312-113 of the Code of Ordinances be amended as follows:

§ 312-113 Schedule XII: Stop and Yield Intersections.

Location	Direction of Travel	At the Intersection of
<u>Scanlon Avenue</u>	<u>West</u>	<u>Florence Road</u>

**CITY OF NORTHAMPTON
MASSACHUSETTS**

In the Year Two Thousand and Twenty-One

Upon the Recommendation of the Transportation and Parking Commission

**21.199
AN ORDINANCE**

**RELATIVE TO STOP SIGNS ON
CROSS STREET**

An Ordinance of the City of Northampton, Massachusetts. Be it ordained by the City Council of the City of Northampton, in City Council assembled, as follows:

SECTION 1

That the § 312-113 of the Code of Ordinances be amended as follows:

§ 312-113 Schedule XII: Stop and Yield Intersections.

Location	Direction of Travel	At the Intersection of
<u>Cross Street</u>	<u>West</u>	<u>Florence Road</u>
<u>Cross Street</u>	<u>East</u>	<u>Bliss Street</u>

**CITY OF NORTHAMPTON
MASSACHUSETTS**

In the Year Two Thousand and Twenty-One

Upon the Recommendation of Mayor David J. Narkewicz and the Department of Public Works

**21.213
AN ORDINANCE**

**RELATIVE TO PARKING ON
PINE STREET**

An Ordinance of the City of Northampton, Massachusetts. Be it ordained by the City Council of the City of Northampton, in City Council assembled, as follows:

SECTION 1

That the § 312-102 of the Code of Ordinances be amended as follows:

§ 312-102 Schedule I: Parking Prohibited All Times.

Location	Side	From	To
Pine Street [Added 8-15-1985]	North-westerly	Chestnut Street	Point 210 feet north-westerly from Chestnut Street South Main Street

**CITY OF NORTHAMPTON
MASSACHUSETTS**

In the Year Two Thousand and Twenty-One

Upon the Recommendation of Mayor David J. Narkewicz and the Department of Public Works

**21.214
AN ORDINANCE**

**RELATIVE TO STOP SIGNS ON
MAPLE STREET, MANN TERRACE, AND PINE STREET**

An Ordinance of the City of Northampton, Massachusetts. Be it ordained by the City Council of the City of Northampton, in City Council assembled, as follows:

SECTION 1

That the § 312-113 of the Code of Ordinances be amended as follows:

§ 312-113 Schedule XII: Stop and Yield Intersections.

A. Isolated stop signs. Stop intersections are established at the following locations:

Location	Direction of Travel	At the Intersection of
Pine Street	East	Maple Street
Pine Street	West	Maple Street
<u>Mann Terrace</u>	<u>North</u>	<u>Pine Street</u>

D. Multiway stop signs. Multiway stop intersections are established at the following locations:

Name of Street	Direction of Travel	Intersection
<u>Pine Street</u>	<u>East/West</u>	<u>Maple Street</u>
<u>Maple Street</u>	<u>North/South</u>	<u>Pine Street</u>

**CITY OF NORTHAMPTON
MASSACHUSETTS**

In the Year Two Thousand and Twenty-One

Upon the Recommendation of Mayor David J. Narkewicz and the Department of Public Works

**21.215
AN ORDINANCE**

**RELATIVE TO TURNING RESTRICTION ON
MANN TERRACE**

An Ordinance of the City of Northampton, Massachusetts. Be it ordained by the City Council of the City of Northampton, in City Council assembled, as follows:

SECTION 1

That the § 312-115 of the Code of Ordinances be amended as follows:

§ 312-115 Schedule XIV: Left Turns Prohibited.

Name of Street	Direction of Travel	Left Turn Prohibited Onto
<u>Mann Terrace</u>	<u>North</u>	<u>Pine Street</u>

**CITY OF NORTHAMPTON
MASSACHUSETTS**

In the Year Two Thousand and Twenty-One

Upon the Recommendation of Mayor David J. Narkewicz and the Department of Public Works

**21.216
AN ORDINANCE**

**RELATIVE TO ONE-WAY STREET ON
MANN TERRACE**

An Ordinance of the City of Northampton, Massachusetts. Be it ordained by the City Council of the City of Northampton, in City Council assembled, as follows:

SECTION 1

That the § 312-112 of the Code of Ordinances be amended as follows:

§ 312-112 Schedule XI: One-Way Streets.

Location	Direction	From	To
Mann Terrace	Northwesterly	A point 60 feet southeasterly of Pine Street	Pine Street

City of Northampton
MASSACHUSETTS

In the Year Two Thousand Twenty-One

Upon the Recommendation of Mayor David J. Narkewicz and Planning & Sustainability

20.181 An Ordinance Relative to Affordable Housing (350-6.12)

An Ordinance of the City of Northampton, Massachusetts, providing that the Code of Ordinances, City of Northampton, Massachusetts, be amended by adding Section 350-6.12 to encourage affordable housing and maximize local control without requiring a Massachusetts Department of Housing and Community Development Site Eligibility Letter and other non-relevant requirements.

Be it ordained by the City Council of the City of Northampton, in City Council assembled, as follows:

Add

350-6.12 Affordable Housing

Whereas, the “Massachusetts Comprehensive Permit Law” (Massachusetts General Law Chapter 40B, Sections 20 to 22) and the “Massachusetts Comprehensive Permit: Low and Moderate Income Housing” regulations (760 CMR 56.00), allow for a single local board to administer and to waive any and all local zoning ordinance and other local ordinances and regulations, as the single approving authority, to encourage affordable housing, upon obtaining a Site Eligibility Letter from the Massachusetts Department of Housing and Community Development (DHCD). Such Site Eligibility Letter creates a burden for some projects, especially small projects. It requires the paying of a fee, the calculation of a developer’s reasonable return, the provision of architectural elevations, among other requirements;

Whereas, it is the City’s intention to provide some zoning relief, consistent with city needs, and while avoiding the need for a DHCD Site Eligibility Letter.

A. All projects approved under this section must meet the following criteria:

1. At least 50% of the residential units being created shall be “Affordable Units.”
2. All permanent energy sources (thermal loads, hot water, and electric loads) shall be from grid-supplied electricity or otherwise not use fossil fuels (natural gas, propane, oil, wood). This shall not apply to emergency generators, outdoor grilling, or mobile energy uses. a).
3. Prior to obtaining a building permit, the applicant shall obtain ~~DHCD~~ approval as Local Initiative Program (LIP) units, so that all affordable units created under this section can be listed by DHCD on their Subsidized Housing Inventory.
4. Prior to obtaining a building permit, the applicant shall obtain Site Plan Approval (Section

; or b) show evidence of Commonwealth funding that requires units be counted on the DHCD SHI

B. The Planning Board may approve Affordable Housing projects as part of a Site Plan Approval when:

- 1. The allowable dwelling units per acre (density) of the entire project is 250% of that otherwise allowed by this zoning ordinance in the zoning district in which the property is located. There are no other minimum lot size requirements for any lots created under this section.**
 - 2. The minimum frontage, lot depth, and lot width is at least 40% of that otherwise required by this zoning ordinance in the zoning district in which the property is located.**
 - 3. When significant trees on the property are cut they shall be replaced on-site with new trees to the extent feasible without blocking solar photovoltaic or hot water systems, but no payment in-lieu is required when such planting is not feasible. Full mitigation is required for cutting public shade trees.**
 - 4. All other zoning applies and is complied with.**
- C. The Planning Board may issue a Special Permit for additional zoning dimensional and density relief when:**
- 1. The application specifically details requested zoning relief to ensure that the project and project permit conditions are not uneconomic, as defined by MGL 40B and 760 CMR 56.00.**
 - 2. The Planning Board finds that the project, with a Special Permit for the requested zoning relief, still meets Local Concerns (as defined in 760 CMR 56.00 and as evidenced by the City's master, comprehensive, and strategic plans).**
 - 3. The Planning Board finds that the Special Permit conditions of Section 350-10 are met.**

In the Year Two Thousand Twenty One

Upon the Recommendation of Mayor David J. Narkewicz and Planning & Sustainability

21.189 AN ORDINANCE TO CREATE INCENTIVE FOR SMALLER HOUSES BY ALLOWING TWO HALF-SCALE UNITS TO COUNT AS A SINGLE-FAMILY FOR DENSITY PURPOSES

An Ordinance of the City of Northampton, Massachusetts, providing that the Code of Ordinances, City of Northampton, Massachusetts, be amended to create an incentive for smaller residential units to be built in the URB and URC districts by allowing Half-Scale units to count as half a single regular sized unit for density purposes. Further, whereas electricity from an electric grid (which must meet state renewable energy portfolio standards and is more easily converted to renewable energy) will facilitate the City's effort to attain carbon neutrality by 2050, new projects created within this proposed zoning shall be built so all on-site systems are fossil fuel-free for thermal and electric loads.

Be it ordained by the City Council of the City of Northampton, in City Council assembled, as follows:

Add a new definition in 350 2.1 as follows:

DWELLING, Half-Scale

A unit that is no larger than 800 square feet of gross living area. Within the table of uses where allowed and for the purposes of calculating total allowable density, two half-scale units shall be treated as one dwelling unit.

Amend Attachment 7(URB) & 8(URC) as follows:

Lot Dimensional Requirements

Lot Size

Single, Two family or Two Half-Scale units: 3,750 ft²

3+ units: 2,500 ft² minimum (min) per unit or per two Half-Scale units

Uses Allowed By Right:

- Single-, two-, three-family, multifamily, townhouses with six or fewer units, or 12 or fewer Half-Scale units. Half-Scale units shall not have any on-site use of fossil fuels (natural gas, propane, oil) for any thermal (heating, cooling, water heating) or electric loads. Electricity from an electric grid and fossil fuel use limited to emergency generators, outdoor grilling, or mobile uses (cars, lawnmowers, snow blowers) are permitted.

Site Plan Approval Required for the Following:

- Any Construction ~~(other than for a single family home or two-family less than 3,400 sf)~~ greater than 2,000 ft² . This requirement applies to all uses except for: single family homes and up to 2 Half-Scale units. Half-Scale units shall not have any on-site use of fossil fuels (natural gas, propane, oil) for any thermal (heating, cooling, water heating) or electric loads. Electricity from an electric grid and fossil fuel use limited to emergency generators, outdoor grilling, or mobile uses (cars, lawnmowers, snow blowers) are permitted.

Special Permit Approval Required for the Following Uses by Planning Board

- Any multifamily or townhouse project creating seven or more units or 14 or more Half-Scale units. Half-Scale units shall not have any on-site use of fossil fuels (natural gas, propane, oil) for any thermal (heating, cooling, water heating) or electric loads. Electricity from an electric grid and fossil fuel use limited to emergency generators, outdoor grilling, or mobile uses (cars, lawnmowers, snow blowers) are permitted.